

# MOLECULAR PROPERTY SPECTROMETER™ (MPS™) FLAMMABLE GAS SENSOR 5.0 USER MANUAL



Series 4 ("S4")



"Mini"

## Notices

SM-UM-0010-09

Copyright © 2018-2026 Nevada Nanotech Systems Inc. All rights reserved.

1395 Greg Street, Suite 102

Sparks, Nevada 89431

## All Rights Reserved

This publication is protected by copyright and all rights are reserved. No part of it may be reproduced or transmitted by any means or in any form, without prior consent in writing from NevadaNano.

The information in this document has been carefully checked and is believed to be accurate. However, changes are made periodically. These changes are incorporated in the newer publication editions. NevadaNano may improve and/or change products described in this publication at any time. Due to continuing system improvements, NevadaNano is not responsible for inaccurate information which may appear in this manual. For the latest product updates, consult the NevadaNano web site at [www.nevadanano.com](http://www.nevadanano.com). In no event will NevadaNano be liable for direct, indirect, special exemplary, incidental, or consequential damages resulting from any defect or omission in this document, even if advised of the possibility of such damages.

In the interest of continued product development, NevadaNano reserves the right to make improvements in this document and the products it describes at any time, without notices or obligation.

The Molecule logo is a trademark of Nevada Nanotech Systems Inc. Use of the logos for commercial purposes without the prior written permission of NevadaNano may constitute trademark infringement and unfair competition in violation of federal and state laws.

NevadaNano, the Molecule logo, Molecular Property Spectrometer, and MPS are trademarks of Nevada Nanotech Systems Inc.

Other trademarks and trade names may be used in the document to refer to either the entities claiming the marks and names or their products. Nevada Nanotech Systems Inc. disclaims any proprietary interest in trademarks and trade names other than its own.



### **Please Recycle**

Shipping materials are recyclable. Please save them for later use or dispose of them appropriately.

## Contents

1.	How the MPS Flammable Gas Sensor 5.0 Works .....	6
2.	Communicating with the MPS Flammable Gas Sensor 5.0.....	7
2.1.	Serial (UART) Communication.....	7
2.1.1.	Data Representation .....	8
2.1.2.	Protocol Specification .....	8
2.1.2.1.	Command Request .....	8
2.1.2.2.	Command Reply.....	9
2.1.2.3.	Status Fields.....	10
2.1.3.	Checksum Calculation.....	12
2.1.4.	Start-Up and Measurement Sequence.....	13
2.1.5.	Command Table.....	18
2.1.6.	Command Descriptions.....	18
2.1.6.1.	Command 0x01 – ANSWER – Read Complete Answer.....	18
2.1.6.2.	Command 0x03 – CONC – Read Flammable Gas Concentration .....	19
2.1.6.3.	Command 0x04 – ID – Read Flammable Gas ID.....	19
2.1.6.4.	Command 0x21 – TEMP – Read Temperature.....	20
2.1.6.5.	Command 0x22 – PRES – Read Pressure .....	20
2.1.6.6.	Command 0x23 – REL_HUM – Read Relative Humidity .....	20
2.1.6.7.	Command 0x24 – ABS_HUM – Read Absolute Humidity .....	20
2.1.6.8.	Command 0x41 – STATUS – Read MPS Status .....	20
2.1.6.9.	Command 0x42 – VERSION – Read MPS Version Info .....	20
2.1.6.10.	Command 0x43 – SENSOR_INFO – Read MPS Sensor Info.....	21
2.1.6.11.	Command 0x61 – MEAS – Perform Measurement.....	21
2.1.6.12.	Command 0x62 – RESET – Reset MPS.....	22
2.1.7.	Configuration Parameters.....	22
2.1.8.	Battery Backup.....	22
2.1.9.	Confidence Signal .....	22
2.2.	Sensor Analog Output Mode .....	22
2.3.	Custom Analog Out Configurations.....	24
2.4.	Analog Out Load Resistance.....	25
3.	Electromechanical Integration .....	26

3.1.	Series 4 (“S4”).....	27
3.2.	MPS Mini.....	28
3.2.1.	Mini Form Factor Critical Dimensions and Pinout .....	28
3.2.2.	Clearances from Heat-Generating Components.....	28
3.2.3.	Enclosure Opening to Sense the Presence of Gas.....	29
3.2.4.	Soldering the MPS Mini Sensor to a PCB .....	29
3.2.5.	Non-Plated Through-Hole Sizing for MPS Mini .....	29
3.3.	Powering the MPS (Series 4 and Mini) .....	32
4.	Testing the MPS Flammable Gas Sensor 5.0 .....	32
4.1.	Typical Test Setups.....	34
4.1.1.	Setup #1: Gas Testing in Various Environmental Conditions .....	34
4.1.2.	Setup #2: General Benchtop Testing .....	35
4.2.	Bump Test Gas Concentrations .....	36
5.	Environmental Faults and Conditions Affecting Accuracy .....	37
6.	Hazardous Locations and System Integration.....	38
7.	Sensor Data for Temperature, Humidity, and Pressure .....	38
8.	Warranty information .....	39
8.1.	MPS Flammable Gas Sensor 5.0 Standard Limited Warranty .....	39

Version	Issue Date (DD/MM/YYYY)	Change
SM-UM-0010-01	08/02/2022	First edition.
SM-UM-0010-02	21/03/2023	Updated figure 6 flowchart, corrected sensor negative concentration on table 12 to -15 %LEL, formatting
SM-UM-0010-03	05/05/2023	Updated sections 3 and 2.1.4; removed "PRELIMINARY" disclaimer
SM-UM-0010-04	10/10/2023	Updated formatting, updated Table 4
SM-UM-0010-05	22/02/2024	Updated formatting, removed unused statuses
SM-UM-0010-06	05/06/2024	Added more detail in the Custom Analog Output Configurations section
SM-UM-0010-07	19/12/2024	Updates to the Start-Up and Measurement Sequence section
SM-UM-0010-08	11/09/2025	Updated drawings of mini with new pin configuration
SM-UM-0010-09	27/04/2026	Added advisory against interrupting the startup sequence

## 1. How the MPS Flammable Gas Sensor 5.0 Works

The MPS Flammable Gas Sensor 5.0 is a smart sensor with built-in environmental compensation that detects and accurately quantifies over a dozen gases as well as gas mixtures. It is intrinsically safe, robust, extremely poison-resistant, and calibrated for all gases by performing only a single calibration with methane. Sensor readings are output on a standard digital bus or industry-standard analog output.

The MPS transducer is a micro-machined membrane with an embedded Joule heater and resistance thermometer. The transducer is mounted on a PCB and packaged inside a filtered enclosure that is permeable to ambient air. Presence of a flammable gas causes changes in the thermodynamic properties of the air/gas mixture. These properties are measured by the transducer and processed by patented algorithms to report an accurate concentration and to classify the flammable gas.

Other sensing technologies (e.g. catalytic bead, NDIR) require a “k-factor” multiplier to convert raw sensor signals to gas concentrations in %LEL. These “k-factors” are based on known relative sensitivities of these sensors to different gases. A single “k-factor”, corresponding to a particular gas, must be selected manually during system setup; if the sensor is then exposed to a gas other than the one selected, significant errors in reported concentration occur.

In contrast, the MPS Flammable Gas Sensor 5.0 applies a real-time conversion factor automatically, using the latest measured thermal properties of the ambient air/gas and the environmental conditions (Figure 1). The %LEL values reported for the bulk, which may contain a mixture of gases, achieve the same high levels of accuracy achieved with single gases. Additional smart algorithms enable determination of the class of gas present, according to the categories in Figure 2.

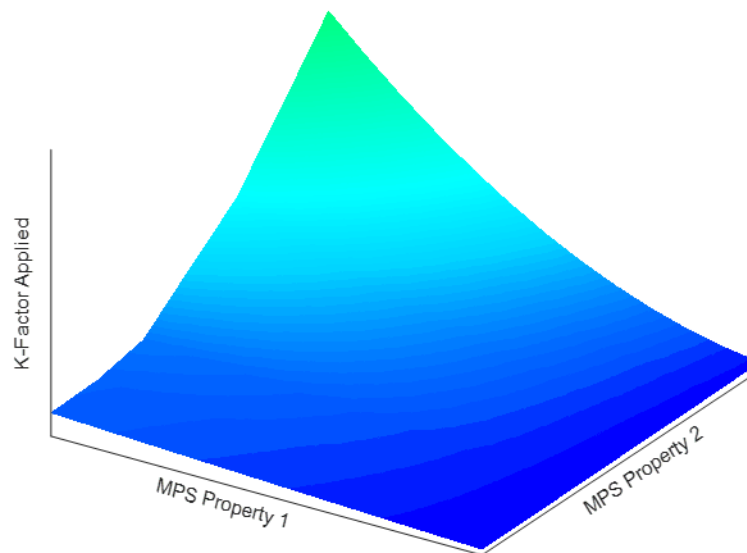

Figure 1: The MPS uses multiple measured properties of the air/gas mixture to automatically apply a real-time conversion factor—enabling high accuracy for over a dozen different gases at all times.

**CLASS 1: Hydrogen**

Molecular Weight: 2.0 [g/mol]  
 Density: 0.09 [kg/m<sup>3</sup>]  
 Number of Carbons: 0



**CLASS 2: Hydrogen Mixture**

Avg. Mol. Weight: 1-14 [g/mol]  
 Avg. Density: 0.1-0.6 [kg/m<sup>3</sup>]  
 Number of Carbons: varies

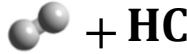

\*This classification is unique as it guarantees the presence of hydrogen and another flammable gas

**CLASS 3: Methane/Natural Gas**

Avg. Mol. Weight: 16 to 19 [g/mol]  
 Avg. Density: 0.6-0.9 [kg/m<sup>3</sup>]  
 Typical Number of Carbons: 0-2

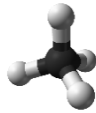

\*Gases having molecular properties similar to that of methane may be classified as methane (e.g. ammonia, acetylene)

**CLASS 4: Light Gas (or Light Gas Mixture)**

Avg. Mol. Weight: 25 to 75 [g/mol]  
 Avg. Density: 1.2-2.5 [kg/m<sup>3</sup>]  
 Typical Number of Carbons: 1-4  
 Example Gases: Ethane, Propane, Isopropanol

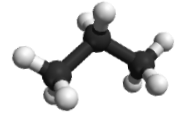

**CLASS 5: Medium Gas (or Medium Gas Mixture)**

Avg. Mol. Weight: 50 to 120 [g/mol]  
 Avg. Density: 1.5-4.0 [kg/m<sup>3</sup>]  
 Typical Number of Carbons: 2-8  
 Example Gas: Pentane

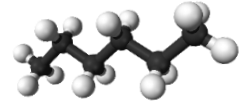

**CLASS 6: Heavy Gas (or Heavy Gas Mixture)**

Avg. Mol. Weight: 80+ [g/mol]  
 Avg. Density: 3.5+ [kg/m<sup>3</sup>]  
 Typical Number of Carbons: 6+  
 Example Gases: Octane, Toluene, Xylene

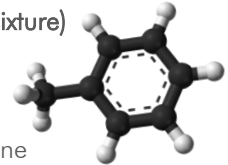

Figure 2: The MPS Flammable Gas Sensor 5.0 outputs the class of gas present. This capability to discriminate amongst gases is what enables the sensor to provide accurate %LEL readings for over a dozen different flammable gases. The MPS is the only technology on the market with this capability.

## 2. Communicating with the MPS Flammable Gas Sensor 5.0

This section describes the software interface requirements for the MPS Flammable Gas Sensor 5.0 and is useful to system integrators when designing the sensor assembly into a final product. The sensor does not need any calibration or maintenance. It communicates over the serial interface using the UART (Universal Asynchronous Receiver/Transmitter) protocol. Alternatively, the sensor can be factory-configured in analog-out mode, where the sensor outputs a voltage proportional to the gas concentration, detailed in Section 2.2.

### 2.1. Serial (UART) Communication

Communication with the system over the serial interface (UART) will allow an external user or system to execute the commands provided in the Command Table in Section 2.1.5. Users may also refer to the Command Descriptions in Section 2.1.6 for usage descriptions.

Serial connection parameters:

Table 1: UART Settings

Parameter	Size
Baud Rate	38400
Data Size	8 bits
Parity	None
Stop Bit	1 bit

### 2.1.1. Data Representation

All integer values (16 bits or 32 bits) are represented in Little Endian format (LSB first). This means when an integer is transmitted on the serial interface, the least significant byte (LSB) is transmitted first and the most significant byte (MSB) is transmitted last.

Floating point numbers are represented in IEEE 754 format.

### 2.1.2. Protocol Specification

Communication to and from the MPS Flammable Gas Sensor 5.0 is made up of “packets.” The communication paradigm is that of “request” and “reply.” An external host sends a “request” packet to the sensor. The sensor returns a “reply” packet to the external host. A packet consists of a fixed size “header” and a variable length “payload.” It is possible for a packet to have no payload (length of zero) where a packet contains only a header. The payload, if any, typically consists of “parameters” for a request or “result” for a reply. Even when a reply does not contain any result, a reply is still sent with the header as an acknowledgement of the request.

#### 2.1.2.1. Command Request

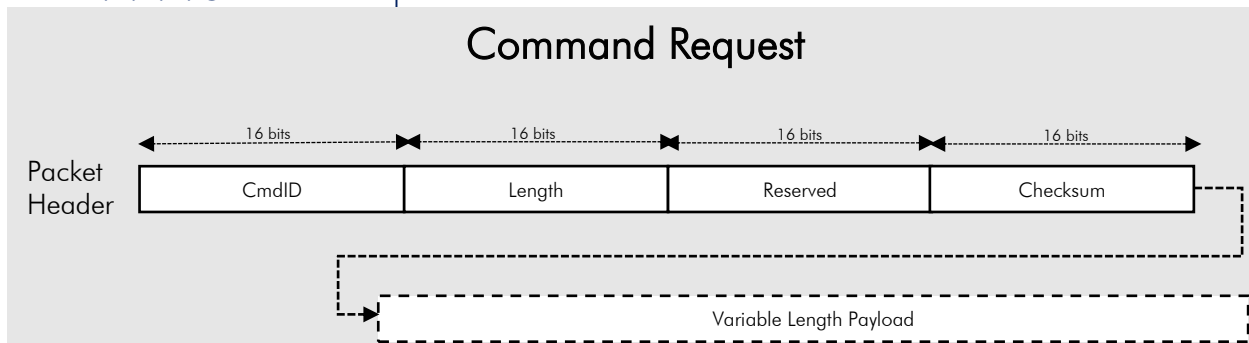

Figure 3: Request Packet Structure.

The Request Packet (Figure 3) consists of the following fields:

Table 2: Request Packet

Field	Size	Description
CmdID	2 Bytes	Command ID of this request (see Command Table in section 2.1.5). Although CmdID uses only 1 byte, it is extended to 2 bytes in the Request Header for alignment purposes.
Length	2 Bytes	Length of the Payload (0 if no payload)
Reserved	2 Bytes	Reserved for future use (zero filled)
Checksum	2 Bytes	Checksum of the entire packet
Variable Length Payload	variable	Command parameters for this request

### 2.1.2.2. Command Reply

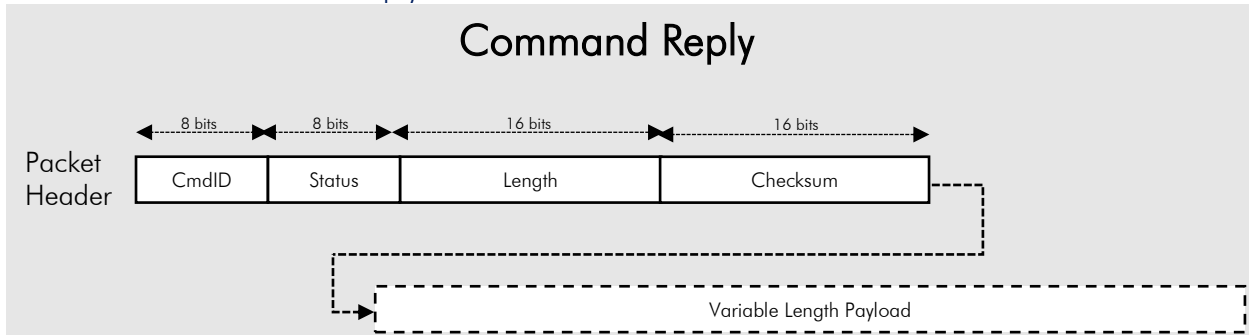

Figure 4: Reply Packet Structure.

The Reply Packet (Figure 4) consists of the following fields:

Table 3: Reply Packet

Field	Size	Description
CmdID	1 Byte	Command ID (should match the original request)
Status	1 Byte	Return status of the request
Length	2 Bytes	Length of the Payload (0 if no payload)
Checksum	2 Bytes	Checksum of the entire packet
Variable Length Payload	variable	Command parameters for this request

### 2.1.2.3. Status Fields

The Status field consists of the following possible return values:

**Table 4: Status field description (table continued on next page)**

Fault	Fault Message	Explanation	%LEL Output	User action
0x00	OK	MPS is operating normally and has no errors	Normal	None.
0x01	CRC_FAILED	Transmitted data failed checksum	N/A	Verify checksum calculation is correct. See Section 0.
0x05	UNKNOWN_COMMAND	Unknown Command ID specified	N/A	Verify Command ID is correct. See Section 2.1.5.
0x07	INCOMPLETE_COMMAND	Incomplete or truncated command	N/A	Verify entire packet header and payload (if any) is fully sent.
0x20	HW_ERR_AO	Analog out malfunction (only if AO functionality enabled)	-100 %LEL	Contact support.
0x21	HW_ERR_VDD	Internal voltage regulator out of range	-100 %LEL	Supply 3.0-5.0 $\pm$ 5% VDC and power cycle. If error persists, contact support.
0x22	HW_ERR_VREF	Internal voltage reference out of range	-100 %LEL	Contact support.
0x23	HW_ENV_XCD_RANGE	Environmental (Temp., Press., Humid.) out of range	Normal	Return sensor to specified operating range. See Section 5.
0x24	HW_ENV_SNSR_MALFUNCTION	Environmental sensor malfunction	-100 %LEL	The sensor was exposed to an extreme environmental condition that can permanently damage it, rendering it unsuitable for accurate readings. As a fail-safe, this error permanently latches the sensor and disables further operation. Sensors that have latched due to exposure to such environmental conditions will not be accepted under warranty.
0x25	HW_ERR_MCU	Microcontroller error	-100 %LEL	Contact support.
0x26	SENSOR_INITIALIZATION	Sensor in initialization mode (6 cycles)	0 %LEL	Do not apply gas during this period. Wait 6 cycles (~12 sec) for sensor to complete initialization.

Fault	Fault Message	Explanation	%LEL Output	User action
0x27	SENSOR_STARTUP	Sensor in start-up mode. No zeroing performed.	-100 %LEL	Do not intentionally apply gas to the sensor during this period or fault 0x33 can occur.
0x30	SENSOR_NEGATIVE	Sensor output < -15%LEL; accuracy affected if flammable gas initially detected while in this condition	-15 %LEL	Wait for sensor to return to zero. If message persists > 10 minutes, contact support.
0x31	CONDENSATION_DETECTED	Condensation condition exists at sensor (out of specification)	Normal	Raise temperature and/or lower humidity. See Section 5.
0x32	HW_SENSOR_MALFUNCTION	MPS transducer malfunction	-100 %LEL	Contact support.
0x33	GAS_DETECTED_DURING_STARTUP	Sensor has detected flammable gas during start-up period	Normal	Sensor integrator recommended to report high gas alarm (>50%LEL) until gas is no longer detected. Re-start sensor in clean air.
0x34	SLOW_GAS_ACCUMULATION_DETECTED	Sensor has detected a slow accumulation of gas	Normal	Sensor integrator recommended to report high gas alarm (>50%LEL) until gas is no longer detected. Re-start sensor in clean air.
0x35	BREATH_OR_HUMIDITY_SURGE	Sensor has detected condition indicative of human breath or humidity surge	Normal	Sensor integrator recommended to not breathe on sensor. Exposure to breath or humidity surges may result in false positive readings.
0x36	WATCHDOG_MCU_RESET	Sensor unexpectedly reset by watchdog	-100 %LEL	Supply 3.0-5.0 $\pm$ 5% VDC, power cycle, and send start measurement command. If message persists, contact support.
0x37	HW_ERR_WATCHDOG	Watchdog malfunction	-100 %LEL	Contact support.
0x38	HW_ERR_DAC_ADC_XCD_RANGE	Sensor internal digital-to-analog or analog-to-digital converter range exceeded.	Normal	Wait for sensor to return to normal status. If message persists, contact support.

### 2.1.3. Checksum Calculation

The algorithm for checksum calculation is that of 16-bit CRC CCITT with start byte 0xFFFF. Checksum is computed over the entire packet (header and payload). The checksum field in the header is initialized with zeros before computing checksum. If there is no payload, checksum is computed against the header only. The following sample C code can be used to calculate the checksum for a buffer of a given size:

```
#include <stdlib.h>
#include <stdint.h>

static uint16_t crc_table[256] = { 0x0000, 0x1021, 0x2042, 0x3063, 0x4084,
0x50a5, 0x60c6, 0x70e7,
 0x8108, 0x9129, 0xa14a, 0xb16b, 0xc18c, 0xd1ad, 0xe1ce, 0xf1ef,
 0x1231, 0x0210, 0x3273, 0x2252, 0x52b5, 0x4294, 0x72f7, 0x62d6,
 0x9339, 0x8318, 0xb37b, 0xa35a, 0xd3bd, 0xc39c, 0xf3ff, 0xe3de,
 0x2462, 0x3443, 0x0420, 0x1401, 0x64e6, 0x74c7, 0x44a4, 0x5485,
 0xa56a, 0xb54b, 0x8528, 0x9509, 0xe5ee, 0xf5cf, 0xc5ac, 0xd58d,
 0x3653, 0x2672, 0x1611, 0x0630, 0x76d7, 0x66f6, 0x5695, 0x46b4,
 0xb75b, 0xa77a, 0x9719, 0x8738, 0xf7df, 0xe7fe, 0xd79d, 0xc7bc,
 0x48c4, 0x58e5, 0x6886, 0x78a7, 0x0840, 0x1861, 0x2802, 0x3823,
 0xc9cc, 0xd9ed, 0xe98e, 0xf9af, 0x8948, 0x9969, 0xa90a, 0xb92b,
 0x5af5, 0x4ad4, 0x7ab7, 0x6a96, 0x1a71, 0x0a50, 0x3a33, 0x2a12,
 0xdbfd, 0xcdbc, 0xfbff, 0xeb9e, 0x9b79, 0x8b58, 0xbb3b, 0xab1a,
 0x6ca6, 0x7c87, 0x4ce4, 0x5cc5, 0x2c22, 0x3c03, 0x0c60, 0x1c41,
 0xedae, 0xfd8f, 0xcdec, 0xddcd, 0xad2a, 0xbd0b, 0x8d68, 0x9d49,
 0x7e97, 0x6eb6, 0x5ed5, 0x4ef4, 0x3e13, 0x2e32, 0x1e51, 0x0e70,
 0xff9f, 0xefbe, 0xdfdd, 0xcffc, 0xbf1b, 0xaf3a, 0x9f59, 0x8f78,
 0x9188, 0x81a9, 0xb1ca, 0xa1eb, 0xd10c, 0xc12d, 0xf14e, 0xe16f,
 0x1080, 0x00a1, 0x30c2, 0x20e3, 0x5004, 0x4025, 0x7046, 0x6067,
 0x83b9, 0x9398, 0xa3fb, 0xb3da, 0xc33d, 0xd31c, 0xe37f, 0xf35e,
 0x02b1, 0x1290, 0x22f3, 0x32d2, 0x4235, 0x5214, 0x6277, 0x7256,
 0xb5ea, 0xa5cb, 0x95a8, 0x8589, 0xf56e, 0xe54f, 0xd52c, 0xc50d,
 0x34e2, 0x24c3, 0x14a0, 0x0481, 0x7466, 0x6447, 0x5424, 0x4405,
 0xa7db, 0xb7fa, 0x8799, 0x97b8, 0xe75f, 0xf77e, 0xc71d, 0xd73c,
 0x26d3, 0x36f2, 0x0691, 0x16b0, 0x6657, 0x7676, 0x4615, 0x5634,
 0xd94c, 0xc96d, 0xf90e, 0xe92f, 0x99c8, 0x89e9, 0xb98a, 0xa9ab,
 0x5844, 0x4865, 0x7806, 0x6827, 0x18c0, 0x08e1, 0x3882, 0x28a3,
 0xcb7d, 0xdb5c, 0xeb3f, 0xfb1e, 0x8bf9, 0x9bd8, 0xabbb, 0xbb9a,
 0x4a75, 0x5a54, 0x6a37, 0x7a16, 0x0af1, 0x1ad0, 0x2ab3, 0x3a92,
 0xfd2e, 0xed0f, 0xdd6c, 0xcd4d, 0xbdaa, 0xad8b, 0x9de8, 0x8dc9,
 0x7c26, 0x6c07, 0x5c64, 0x4c45, 0x3ca2, 0x2c83, 0x1ce0, 0x0cc1,
 0xef1f, 0xff3e, 0xcf5d, 0xdf7c, 0xaf9b, 0xbfba, 0x8fd9, 0x9ff8,
 0x6e17, 0x7e36, 0x4e55, 0x5e74, 0x2e93, 0x3eb2, 0x0ed1, 0x1ef0,
};

uint16_t crc_generate(uint8_t *buffer, size_t length, uint16_t startValue)
{
  uint16_t crc;
  uint8_t *p;
  int ii;

  crc = startValue;

  for(p = buffer, ii = 0; ii < length; ii++) {
```

```
    crc = (crc << 8) ^ crc_table[(crc >> 8) ^ *p];  
    p++;  
}  
  
return crc;  
}
```

For more information on how to use the above function, please look at the sample test program “Sample Code” located here: <https://nevanano.com/downloads>

#### 2.1.4. Start-Up and Measurement Sequence

Figure 5 describes the recommended steps after powering on the sensor, as well as the measurement sequence for getting answer data. The major steps consist of the following:

1. After powering on the sensor, wait for the sensor to boot up completely (~3 seconds). This is needed for the sensor to complete its self-test sequence which cannot be skipped and is executed at every power-up.
2. Verify communication channel by asking the sensor for version information.
  - a. Protocol version can be used to determine available commands, answers, or new data.
3. Start measurement in “continuous” mode.
4. Wait for the first measurement to complete.
  - a. This takes ~2 seconds.
5. Get Answer.
6. Repeat process to get answer at the rate shown in .

*Note: It takes approximately 2 seconds to complete a measurement after start-up sequence. If multiple requests to read the answer register (0x01) are made within a 2-second window, one might get the same answer, depending on whether a new measurement is calculated between multiple answer requests. The MPS cycle count in the answer response is incremented after each measurement is calculated. Therefore, when processing an answer, one should compare the count in the answer against the count from the previous answer. If the count did not increment, this a repeated answer. If the count incremented, this is a new answer from the latest measurement cycle. When continuous measurement is stopped and restarted, the count resets to 1 with the first measurement.*

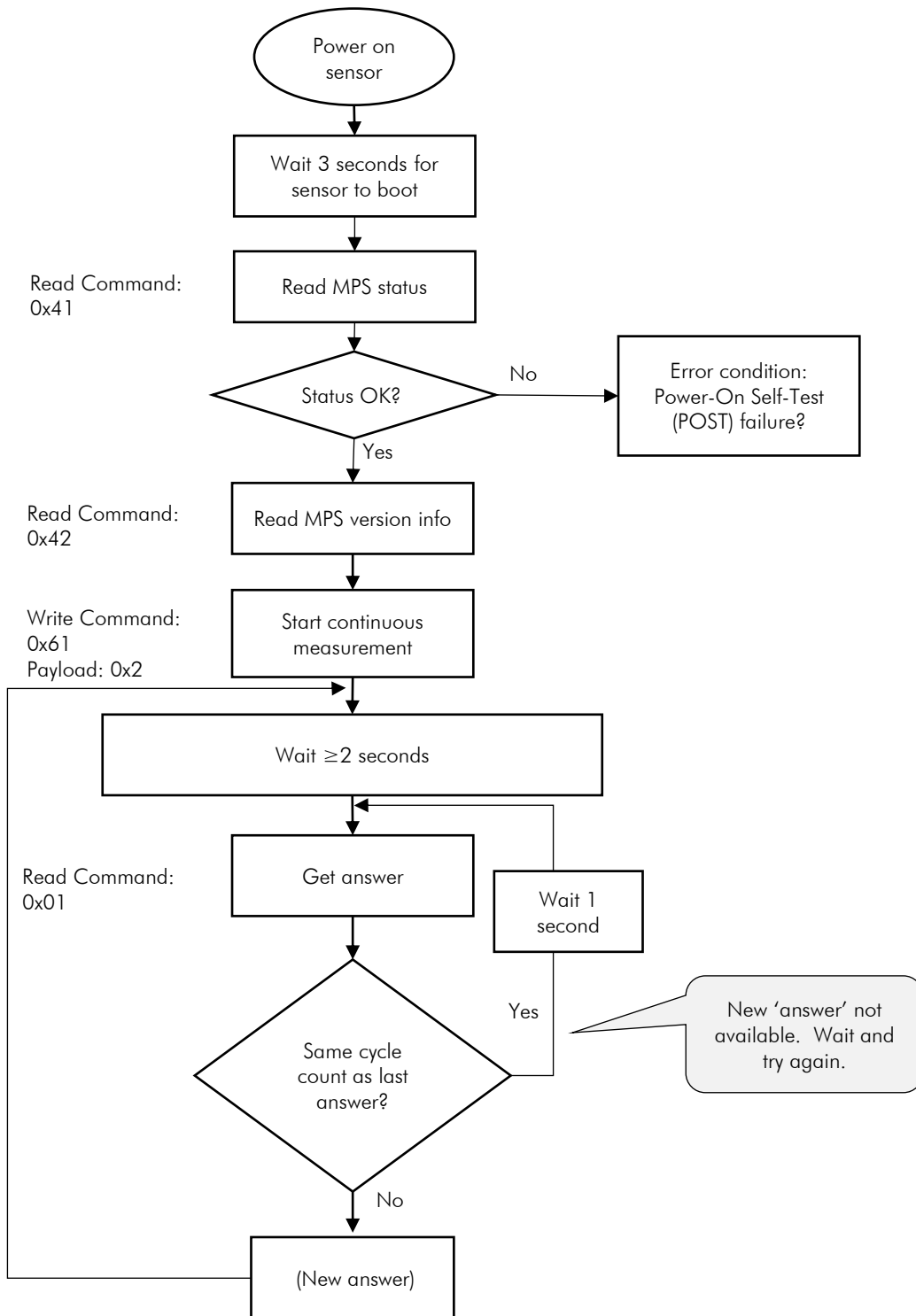

Figure 5: Typical Command and Reply Sequence.

Upon issuing the “start measurement” command, the MPS begins its start-up sequence, detailed in Figure 6. For the first 31 seconds, the status is set to SENSOR\_STARTUP, the concentration is set to -100 %LEL, and the sensor will not respond to gas. After this, the sensor will check for the presence of gas on cycles 1 through 16, each cycle lasting 2 seconds. **During the first 31 seconds after starting measurements, the sensor is performing a self-cleaning step. During this step, it is possible to damage the MPS transducer if power is removed from the sensor or if the sensor is interrupted by a “stop measurement” (0x61 with a payload of 0x03) command or the reset command (0x62). To avoid this, best practice is to wait 60 seconds after continuous measurements start before interrupting the sensor.**

- If gas is not detected at any point in the first 16 cycles, the sensor remains in the SENSOR\_STARTUP status and the concentration reported is 0 %LEL. It will then proceed to the initialization phase, lasting 6 cycles (12 seconds), during which the status is set to SENSOR\_INITIALIZATION and concentration is 0 %LEL. Once initialization is complete, the status is set to 0x00. ***Note: The sensor provides TrueLEL accuracy, gas ID capability, and the full 0-100 %LEL detection range only for gases arriving after initialization.***
- If gas *is* detected during any of the first 16 cycles, a %LEL concentration is reported (for analog output sensors, the voltage is set to warning level, 2.3 V if using default configuration), the status is set to GAS\_DETECTED\_DURING\_STARTUP, the gas ID defaults to 253 (“Unknown Gas”). The “k-factor” for methane will be used to calculate concentration in %LEL. The sensor will continue to give the GAS\_DETECTED\_DURING\_STARTUP status and to take new readings for all 16 cycles, and for all cycles thereafter while gas is still being detected. The sensor *will not* proceed to the initialization phase nor enter TrueLEL mode until gas is no longer detected. It is recommended that the integrator reports high gas alarm (>50 %LEL) while the GAS\_DETECTED\_DURING\_STARTUP status persists. ***Note: the MPS does not provide TrueLEL concentration accuracy, gas identification accuracy, nor detect the concentration ranges specified on the datasheet for gases already present before, or arriving during, start-up and initialization.*** Once gas is no longer detected, the sensor will proceed to the initialization phase.

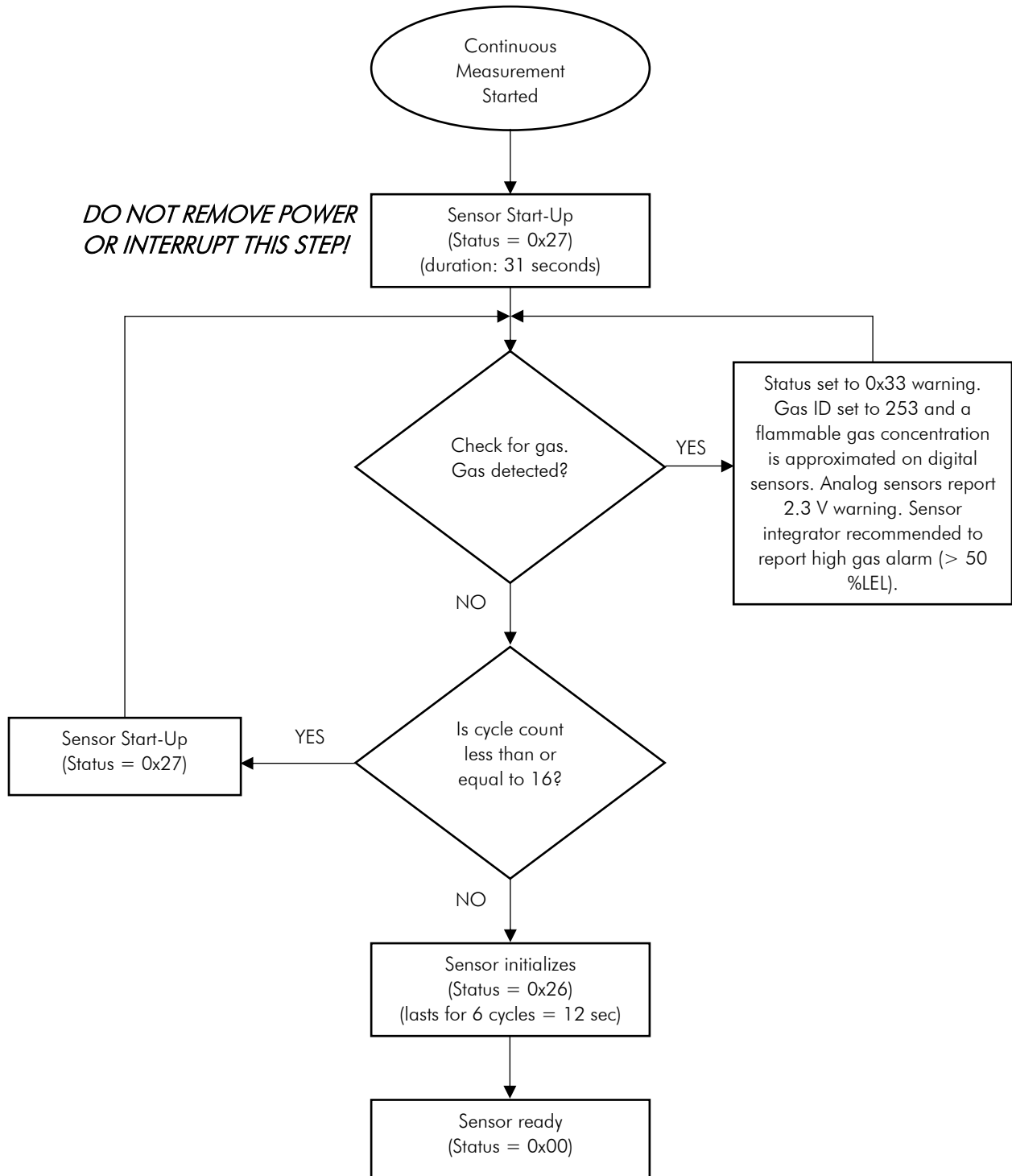
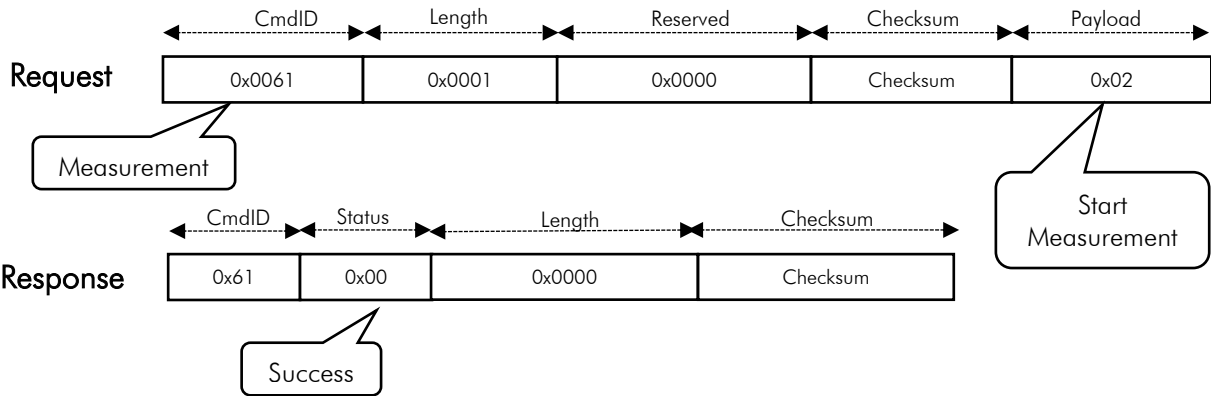

Figure 6: Sensor Start-up Sequence.

Figure 7 describes sample Request and Response packets for the Perform Measurement and Get Answer Vector sequences.

## Perform Measurement



## Get Answer Vector

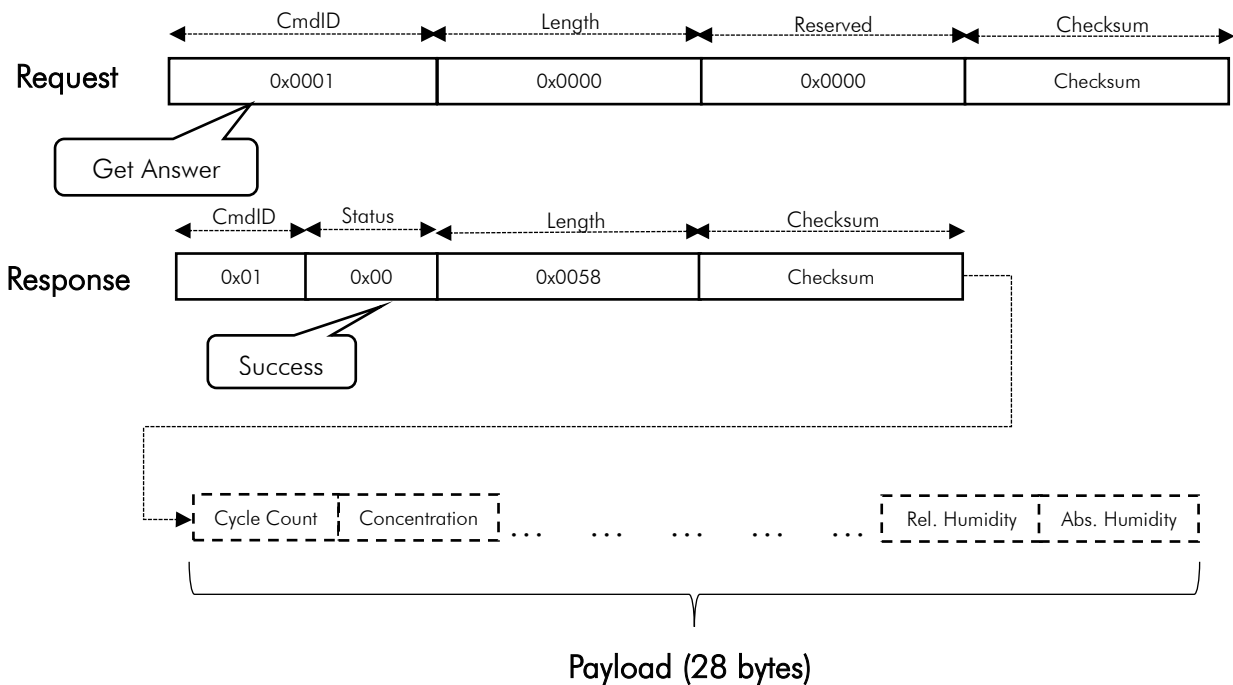

Figure 7: Sample Request and Response Packets for Performing Measurement and Get Answer Vector.

## 2.1.5. Command Table

Table 5: UART commands with calculated checksum

Hex Code	Command ID	Payload Length [bytes]		Request Packet (Little-Endian Format)				
		Request	Response	CmdID	Length	Reserved	Calculated Checksum*	Payload
0x01	ANSWER	0	28	0x01 0x00	0x00 0x00	0x00 0x00	0xed 0x76	null
0x03	CONC	0	4	0x03 0x00	0x00 0x00	0x00 0x00	0x4b 0xf9	null
0x04	ID	0	4	0x04 0x00	0x00 0x00	0x00 0x00	0x53 0x3e	null
0x21	TEMP	0	4	0x21 0x00	0x00 0x00	0x00 0x00	0x85 0x0d	null
0x22	PRES	0	4	0x22 0x00	0x00 0x00	0x00 0x00	0xf0 0xc5	null
0x23	REL_HUM	0	4	0x23 0x00	0x00 0x00	0x00 0x00	0x23 0x82	null
0x24	ABS_HUM	0	4	0x24 0x00	0x00 0x00	0x00 0x00	0x3b 0x45	null
0x41	STATUS	0	1	0x41 0x00	0x00 0x00	0x00 0x00	0x3d 0x80	null
0x42	VERSION	0	8	0x42 0x00	0x00 0x00	0x00 0x00	0x48 0x48	null
0x43	SENSOR_INFO	0	100	0x43 0x00	0x00 0x00	0x00 0x00	0x9b 0x0f	null
0x61	MEAS	1	0	0x61 0x00	0x01 0x00	0x00 0x00	0x57 0x93	0x02
0x61	MEAS	1	0	0x61 0x00	0x01 0x00	0x00 0x00	0x35 0xb7	0x22
0x61	MEAS	1	0	0x61 0x00	0x01 0x00	0x00 0x00	0x76 0x83	0x03
0x62	RESET	0	0	0x62 0x00	0x00 0x00	0x00 0x00	0x20 0x33	null

\*Checksum is calculated from the example shown in this table. Refer to section 2.1.3 for checksum calculation.

## 2.1.6. Command Descriptions

### 2.1.6.1. Command 0x01 – ANSWER – Read Complete Answer

Description: Returns a complete answer in one read operation.

Parameters: N/A

Response:

CYCLE_COUNT	32-bit signed value. Cycle Number of this measurement (incremented after each measurement)
CONC	32-bit floating point value. Flammable gas concentration [%LEL (ISO) or %LEL (IEC)]
ID	32-bit unsigned value. Flammable gas ID. See “Command 0x04 – ID” for descriptions of gas ID values.
TEMP	32-bit floating point value. Ambient temperature [°C]
PRESSURE	32-bit floating point value. Ambient pressure [kPa]
REL_HUM	32-bit floating point value. Ambient relative humidity [%RH]
ABS_HUM	32-bit floating point value. Ambient absolute humidity [ $\frac{g}{m^3}$ ]

### 2.1.6.2. Command 0x03 – CONC – Read Flammable Gas Concentration

Description: Returns flammable gas concentration [%LEL (ISO) or %LEL (IEC)] as measured by the MPS.

Parameters: N/A

Response: CONC 32-bit floating point value. Flammable gas concentration [%LEL (ISO) or %LEL (IEC)]

Table 6: Gas concentration

Concentration	Description & Sensor Outputs
< -15.0 %LEL	Reported concentration is -15 %LEL. Gas ID set to 254 (Under Range). SENSOR_NEGATIVE status.
≥ -15.0 %LEL and < -5 %LEL	Reports measured concentration. Gas ID set to 254 (Under Range).
≥ -5 %LEL and ≤ 0 %LEL	Reports 0 %LEL concentration. Gas ID set to 0.
> 0 %LEL and < 110 %LEL	Reports measured concentration.
≥ 110 %LEL	Reported concentration is 110 %LEL. Gas ID set to 255 (Over Range).

### 2.1.6.3. Command 0x04 – ID – Read Flammable Gas ID

Description: Returns flammable gas ID as determined by the MPS.

Parameters: N/A

Response: ID 32-bit unsigned value. Flammable gas ID.

Table 7: Gas ID details

ID	Description
0	No Gas
1	Hydrogen
2	Hydrogen Mixture
3	Methane
4	Light Gas
5	Medium Gas
6	Heavy Gas
253	Unknown Gas
254	Under Range – Concentration less than -5 %LEL
255	Over Range – Concentration greater than or equal to 110 %LEL

**Note:** All gas IDs, including Under Range and Over Range conditions, will continue to be output on every cycle until the determined ID value changes.

#### 2.1.6.4. Command 0x21 – TEMP – Read Temperature

Description: Returns the ambient temperature (°C) as reported by the integrated environmental sensor.

Parameters: N/A

Response: TEMP 32-bit floating point value. Ambient temperature (°C).

#### 2.1.6.5. Command 0x22 – PRES – Read Pressure

Description: Returns the ambient pressure (kPa) as reported by the integrated environmental sensor.

Parameters: N/A

Response: PRESSURE 32-bit floating point value. Ambient pressure (kPa).

#### 2.1.6.6. Command 0x23 – REL\_HUM – Read Relative Humidity

Description: Returns the ambient relative humidity (%RH) as reported by the integrated environmental sensor.

Parameters: N/A

Response: REL\_HUM 32-bit floating point value. Ambient relative humidity (%RH).

#### 2.1.6.7. Command 0x24 – ABS\_HUM – Read Absolute Humidity

Description: Returns the ambient absolute humidity ( $\frac{g}{m^3}$ ) as calculated by the MPS.

Parameters: N/A

Response: ABS\_HUM 32-bit floating point value. Ambient absolute humidity ( $\frac{g}{m^3}$ ).

#### 2.1.6.8. Command 0x41 – STATUS – Read MPS Status

Description: Returns the status of the MPS; refer to Sec. 2.1.2.3 for status descriptions.

Parameters: N/A

Response: STATUS 8-bit unsigned value. Status of MPS.

#### 2.1.6.9. Command 0x42 – VERSION – Read MPS Version Info

Description: Returns the software, hardware and protocol versions of the MPS.

Parameters: N/A

Response: SW\_VERSION 8-bit unsigned values. Version is W.X.Y.Z  
HW\_VERSION 8-bit unsigned values. Version is W.X  
PROTOCOL\_VERSION 8-bit unsigned values. Version is W.X

**Table 8: MPS version info**

MPS Version Info																															
1	2	3	4	5	6	7	8	9	10	11	12	13	14	15	16	17	18	19	20	21	22	23	24	25	26	27	28	29	30	31	32
SW Version W [7:0]								SW Version X [7:0]								SW Version Y [7:0]								SW Version Z [7:0]							
33	34	35	36	37	38	39	40	41	42	43	44	45	46	47	48	49	50	51	52	53	54	55	56	57	58	59	60	61	62	63	64
HW Version W [7:0]								HW Version X [7:0]								Protocol Version W [7:0]								Protocol Version X [7:0]							

**2.1.6.10. Command 0x43 – SENSOR\_INFO – Read MPS Sensor Info**

Description: Returns information about the sensor.

Parameters: N/A

Response:

SERIAL_NUM	Sensor serial number. 32 bytes, zero-padded ASCII string.
SENSOR_TYPE	Sensor type. 32-bit unsigned integer. (Note: “MPS Flammable Gas Sensor 5.0” SENSOR_TYPE = 0x03)
SENSOR_SKU	SKU of the sensor. 32 bytes, zero-padded ASCII string.
CAL_DATE	Date of last calibration. 16 bytes, zero-padded ASCII string. Format is MM/DD/YYYY.
MFG_DATE	Date of manufacture. 16 bytes, zero-padded ASCII string. Format is MM/DD/YYYY.

**2.1.6.11. Command 0x61 – MEAS – Perform Measurement**

Description: Sets the sensing mode (idle, single, or continuous) and “concentration unit” in the measurement.

Parameters: The parameter to the Measurement command is 1 byte in length but consists of two, 4-bit values: Concentration Unit (bits 7:4) and Mode (bits 3:0).

**Table 9: Measurement command**

Measurement Value (Byte)	
Conc. Unit [7:4]	Mode [3:0]

The “concentration unit” (bits 7:4 of the measurement byte) can be either %LEL (ISO) or %LEL (IEC). By specifying the desired unit, the response for commands 0x01 (read answer) and 0x03 (read concentration) will be either %LEL (ISO) or %LEL (IEC). Invalid “concentration unit” parameters are defaulted to 0x0.

**Table 10: Concentration unit**

Unit	Name	Description
0x0	PERCENT_LEL (ISO)	Concentration reported as %LEL in accordance with ISO 10156
0x2	PERCENT_LEL (IEC)	Concentration reported as %LEL in accordance with IEC 60079-20-1

The measurement mode (bits 3:0 of the measurement byte) consists of the following possible values:

Table 11: Measurement mode

Mode	Name	Description
0x2	MPS_CONT	MPS operates in an autonomous, continuous mode
0x3	MPS_STOP	Stop measurement – no measurements are being taken <b>It is recommended this command is sent only if the sensor has been operating in continuous mode for at least 60 seconds!</b>

Response: N/A

#### 2.1.6.12. Command 0x62 – RESET – Reset MPS

Description: Perform a soft reset of the MPS, clearing all data and states.

Parameters: N/A

Response: N/A

### 2.1.7. Configuration Parameters

All configuration parameters related to the sensor are set by NevadaNano during manufacturing. The sensor does not support any user adjustable parameters.

### 2.1.8. Battery Backup

The sensor does not have a battery backup. On power loss, the sensor stops measurements and all “Answer” data are lost. Critical configuration parameters however remain stored and unchanged.

### 2.1.9. Confidence Signal

A confidence signal is an indicator that the sensor is working as expected. In MPS sensors, there are three confidence signals:

- The cycle count incrementing by one every ~2 seconds (digital communication).
- The sensor status code returned in the “Answer” data (digital communication).
- The output voltage on the Analog Out channel (analog communication).

## 2.2. Sensor Analog Output Mode

The MPS Flammable Gas Sensor 5.0 includes versions that are factory-configurable to report gas concentrations via an analog signal that mimics the output of conventional catalytic bead flammable gas sensors. If you are working with a sensor where analog output is enabled (refer to the Part Number Ordering Guide in the datasheet), the analog output signal is generated with a digital-to-analog converter. The standard analog output configuration, shown in Figure 8, outputs 0.4 V at 0 %LEL and 2.0 V at 100 %LEL, linearly increasing at 0.016 V/%LEL. The MPS Flammable Gas Sensor 5.0 comes in two primary varieties: (1) a 5-Pin digital version, with UART interface plus the analog output signal, where the digital interface initializes measurements for both digital output via the Tx and Rx pins as well as measurement results on the analog output pin, and (2) a 3-Pin sensor with only

analog output that uses “auto start” to begin reading out concentration measurements on the analog output pin. As with the digital communication mode, the MPS output concentration resolution is 0.1 %LEL for analog outputs.

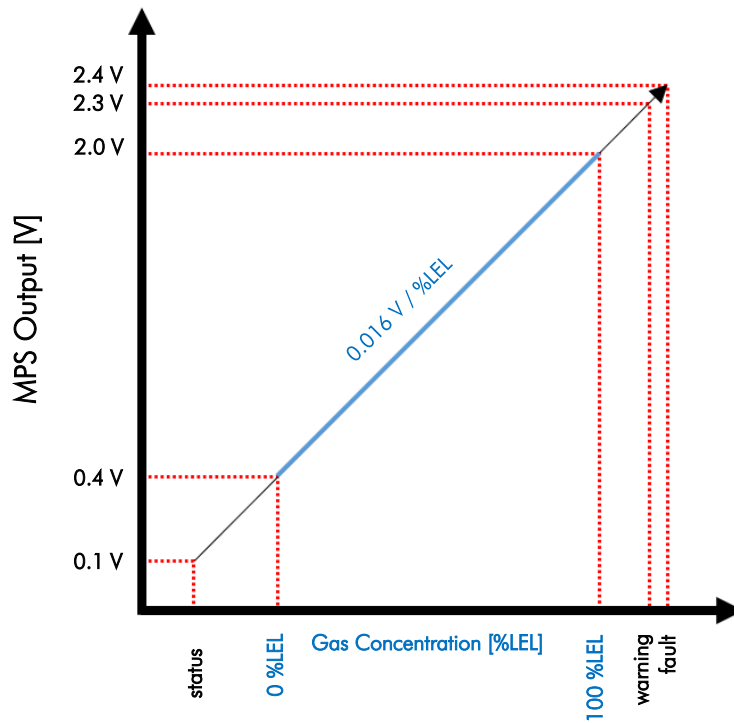

Figure 8: MPS Flammable Gas Sensor 5.0 output when configured in standard analog output mode. Note that the sensor will report down to -15 %LEL (0.16V) and up to 110 %LEL (2.16V) in the standard analog configuration.

When there is an error condition or special status, as reported by the sensor status field (outlined in Section 2.1.2.3), the voltage level does not indicate gas concentration. Instead, the voltage is set to report an error or special status. Only critical statuses, messages that indicate the sensor’s initialization sequence, or the indication that the sensor output is negative are conveyed to the user. Non-critical status messages (e.g.: HW\_ENV\_XCD\_RANGE, HW\_CONDENSE\_COND) are not reported in analog output mode. The following table indicates the output voltage corresponding to each sensor message and critical status. Refer to Section 2.3 for more information about custom, configurable voltage output options.

Table 12: Analog output voltages for various %LEL readings, statuses, faults, and warnings.

Analog Out Parameter	Status(es)	Standard Output [V]	Custom Configurable Output [V]
0 to 100 %LEL	n/a	0.4 to 2.0	0.1 to 2.4
-15 to 0 %LEL	n/a	0.16 to 0.4	0.1 to 2.4
100 to 110 %LEL	n/a	2.0 to 2.16	0.1 to 2.4
Sensor Startup	<ul style="list-style-type: none"> <li>• SENSOR_STARTUP (Phase 1)</li> </ul>	0.1	0.1 to 2.4
Sensor Status	<ul style="list-style-type: none"> <li>• SENSOR_STARTUP (Phase 2)</li> <li>• SENSOR_INITIALIZATION</li> <li>• SENSOR_NEGATIVE (&lt; -15 %LEL)</li> </ul>	0.1	0.1 to 2.4
Sensor Warning	<ul style="list-style-type: none"> <li>• SENSOR_GAS_DETECTED_DURING_STARTUP</li> <li>• SLOW_GAS_ACCUMULATION_DETECTED</li> </ul>	2.3	0.1 to 2.4
Sensor Fault	<ul style="list-style-type: none"> <li>• HW_ERR_VDD</li> <li>• HW_ERR_AO</li> <li>• HW_ERR_VREF</li> <li>• HW_ENV_SNSR_MALFUNCTION</li> <li>• HW_ERR_MCU</li> <li>• HW_SENSOR_MALFUNCTION</li> <li>• HW_ERR_WATCHDOG</li> <li>• HW_ERR_DAC_ADC_XCD_RANGE</li> </ul>	2.4	0.1 to 2.4

### 2.3. Custom Analog Out Configurations

The analog out voltage can be configured on both the 3-pin and the 5-pin versions of the MPS Flammable Gas Sensor 5.0. Custom configurations are set at the factory and are not customer configurable. Analog out voltages below 0.05 volts or above 2.45 volts are outside the range of standard outputs. If such voltages are found to persist for more than five sensor cycles (10 seconds) it should be regarded as a sensor malfunction.

The customizable analog out parameters and their ranges are:

- **Sensor Fault**,  $0.1 \text{ volts} < V_{\text{FAULT}} \leq 2.4 \text{ volts}$ 
  - This is the analog output voltage corresponding to a sensor fault condition.
- **Sensor Warning**,  $0.1 \text{ volts} < V_{\text{FAULT}} \leq 2.4 \text{ volts}$ 
  - This is the analog output voltage corresponding to a sensor warning condition.
- **Sensor Status**,  $0.1 \text{ volts} < V_{\text{STATUS}} \leq 2.4 \text{ volts}$ 
  - This is the analog output voltage corresponding to a sensor status condition, as well as during the Sensor Start Up Phase 2.
- **Sensor Startup**,  $0.1 \text{ volts} < V_{\text{STATUS}} \leq 2.4 \text{ volts}$ 
  - This is the analog output voltage corresponding to Sensor Start Up Phase 1.
- **0 %LEL Voltage**,  $0.1 \text{ volts} < V_0 \leq 2.4 \text{ volts}$ 
  - This is the analog output voltage corresponding to a gas concentration of 0 %LEL.
- **Voltage Sensitivity Slope**,  $-0.02 < V_{\text{SLOPE}} \leq 0.02 \text{ volts/\%LEL}$

- This is the analog output slope that relates voltage to a gas concentration. This will dictate what the 100 %LEL and the 110 %LEL readings will be.

Figure 9 shows the voltages that can (green shades) and cannot (red) be configured during the startup phases of the sensor. The voltages that cannot be configured only occur when power is first applied to the sensor.

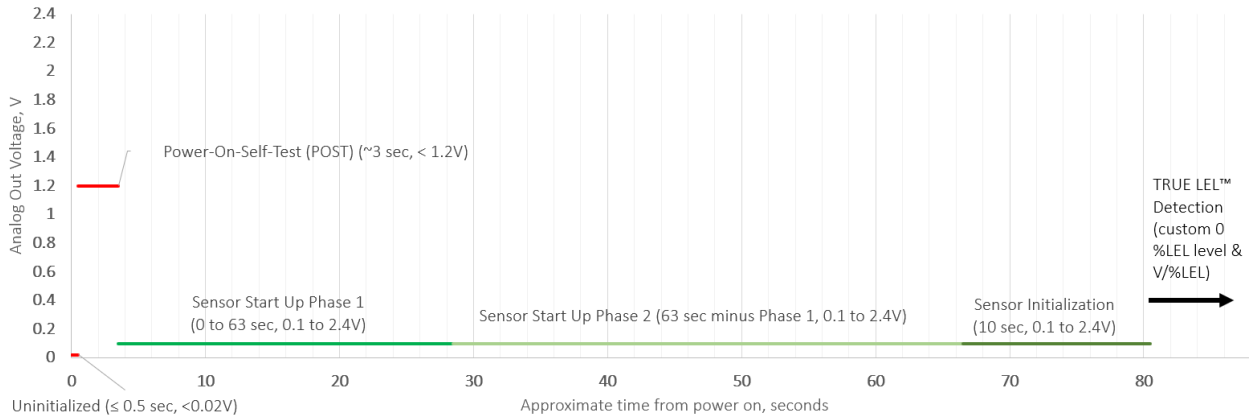

Figure 9: MPS Flammable Gas Sensor 5.0 startup sequence with analog out configurations. The times shown are approximate, as POST, while typically about 3 seconds, can have variable duration.

## 2.4. Analog Out Load Resistance

Figure 10 shows a simple schematic of the analog output stage of the MPS sensor connected to a detector with a given detector load resistance.

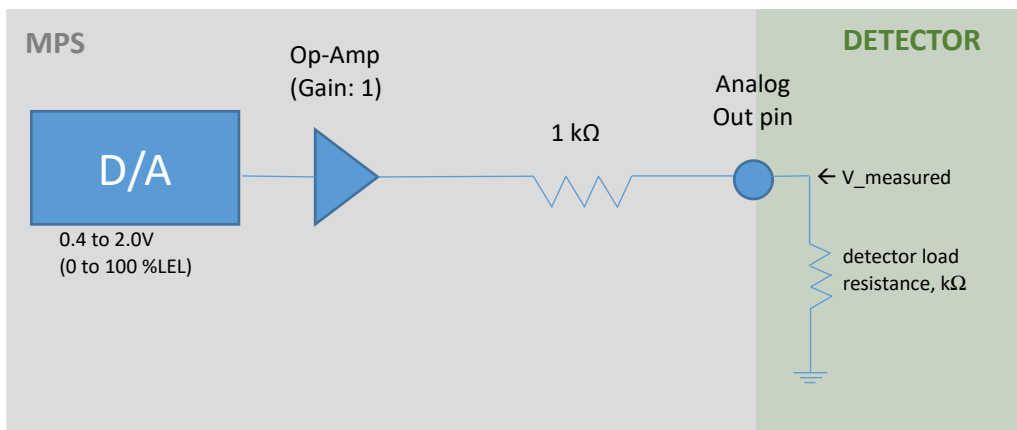

Figure 10: Analog output stage of the MPS and input stage of detector.

The 1-k $\Omega$  series resistor in the MPS limits the current that the analog output can provide in order to prevent damage to the sensor should the output be shorted. Systems using the analog output pin need to take this current drive limit into account when designing an input circuit to measure the analog voltage.

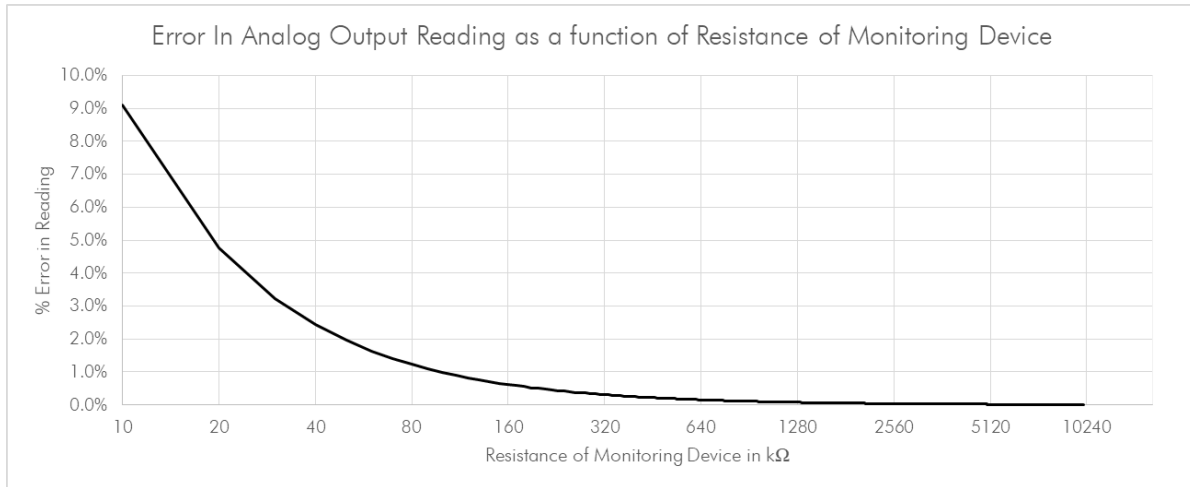

Figure 11: Percent error in voltage reading (i.e. the error in “V<sub>measured</sub>” in Figure 10) versus resistance load (i.e., the “detector load resistance” shown in Figure 10).

For example, as shown in Figure 11, a load of 100 kΩ on the analog output pin will result in a 1% error in the voltage reading (and therefore a 1% error in %LEL reading). System designers should account for this when implementing systems using the analog out signal from the MPS.

### 3. Electromechanical Integration

The MPS Flammable Gas Sensor 5.0 is available in two form factors: Series 4 (“S4”), and “Mini.”

The S4 has the same cylindrical shape and dimensions as many industry-standard (catalytic and infrared-type), “4 series” combustible gas sensors and is Intrinsically Safe (IS) certified.

The Mini is rectangular in shape and has a low profile. It consists of a single-PCB sensor with integrated housing and a header-type interface connector and is not Intrinsically Safe (IS) certified.

The specific dimensions of each form factor are listed in their respective sections below.

To improve water ingress protection of either form factor, a user may elect to affix a microporous membrane (e.g., Porex PTFE PM21ML) to the sensor intake. The addition of such a membrane may slow the speed of response, dependent upon the gas. Lighter gases (e.g., methane) are relatively unaffected; however, for heavier gases like toluene and xylene, one can expect slower response times and some suppression of reported concentration.

The sensor housings of both the S4 and Mini form factors are not sufficiently smooth at a microscopic level to expect gaskets to form a perfectly gas- or liquid-tight seal.

### 3.1. Series 4 (“S4”)

The Series 4 pinout and critical dimensions are indicated in Figure 12. The sensor interface pins are compatible with the following receptacles (one receptacle per pin) or socket assemblies (one socket per sensor):

Manufacturer	Part number	Description
Mill-Max	9401-0-15-15-23-27-10-0	Closed bottom, individual pin receptacle
Mill-Max	0384-0-67-80-23-27-10-0	Open bottom, individual pin receptacle
Andon	R420-SP05-04T-436P55-R27-L14	5-pin, through-hole socket assembly
Andon	R420-SP05-04T-440P55-R27-L14	5-pin, surface-mount socket assembly
Andon	R300-SP03-02T-436P55-R27-L14	3-pin, through-hole socket assembly
Andon	R300-SP03-02T-440P55-R27-L14	3-pin, surface-mount socket assembly

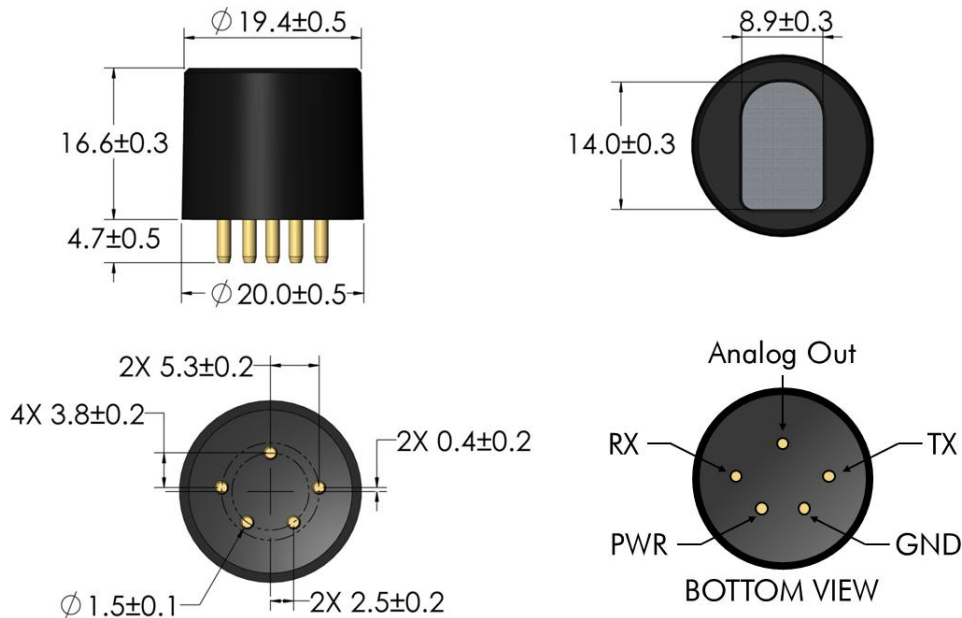

Figure 12: MPS Flammable Gas Sensor 5.0 S4 form factor mechanical dimensions (in mm) and pinout. Note that TX and RX pins are not present in “3-pin” configurations.

Do not solder to the S4 pins. This will void the warranty.

The “S4” is a standard “4 series” size – 20 mm  $\varnothing$ , and 16.6 mm high. The sensor housing is constructed from Ultem PEI plastic. The sensor holds an ATEX-default IP2X rating, and has passed additional testing in accordance with MIL-STD-810G Method 510.5 for dust resistance. The sensor is susceptible to liquid ingress and will not function properly if water or other liquids inundate the sensor chamber.

### 3.2. MPS Mini

The Mini form factor is designed to be permanently mounted to a printed circuit board. The male header is Samtec P/N: TLW-105-06-G-S and the female connector is Samtec P/N: SLW-105-01-G-S. Both interconnects are readily available in distribution. In addition to the electrical interconnects, the Mini package has two plastic locating features. These locating features can engage with a through-hole on the PCB for more precise and secure locating of the sensor relative to the PCB.

#### 3.2.1. Mini Form Factor Critical Dimensions and Pinout

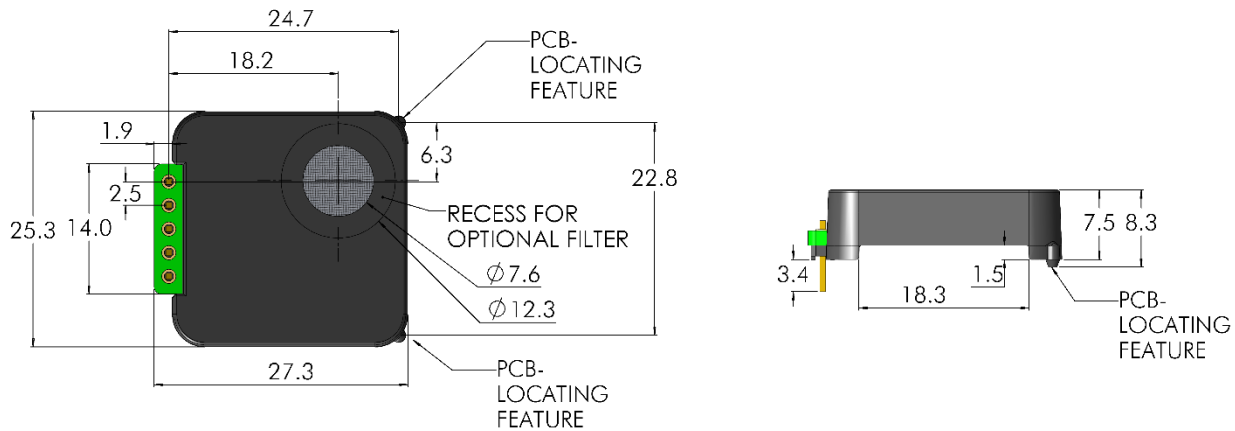

Figure 13: Mini critical dimensions (mm).

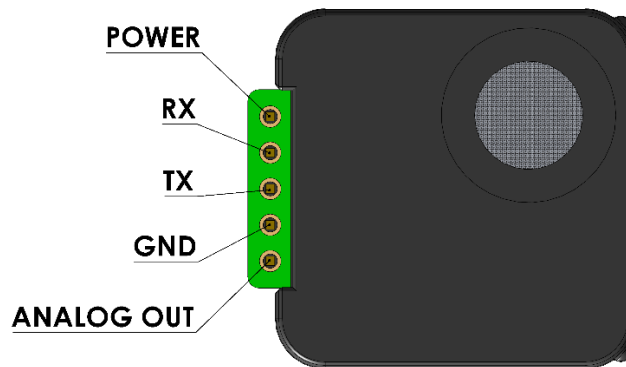

Figure 14: Mini electrical pinout configuration.

#### 3.2.2. Clearances from Heat-Generating Components

When designing the PCB layout to integrate the MPS Mini, consideration should be given to the location of any significant heat-generating components either adjacent to or under the sensor. All MPS sensor designs utilize an environmental monitoring system internal to the sensor to make accurate measurements of temperature, pressure, and humidity, and to compensate for these environmental effects. Components that raise the ambient temperature in the vicinity of the MPS—

especially locally, where one portion of the Mini is heated more than other portions—could lead to inadequate environmental compensation and/or inaccurate gas reporting. Careful consideration should be given to avoid raising the ambient temperature in the vicinity of the MPS by more than about 3 °C.

### 3.2.3. Enclosure Opening to Sense the Presence of Gas

The goal when designing the opening in the application enclosure should be to allow the MPS Mini clear, unobstructed access to the external environment to be sensed and to not allow the buildup of “stale” air or gases of interest in the application enclosure. Doing so could adversely affect the response of the MPS Mini sensor. The opening in the application enclosure to allow the MPS Mini sensor to detect gases should consider the following criteria:

- The opening in the application enclosure through which gases flow to the Mini should be no smaller than the opening in the top of the MPS Mini sensor.
- The MPS Mini sensor should be located as close to the external opening of the application enclosure as possible.
- The space between the MPS Mini sensor and the inner surface of the application enclosure should include a gasket sealing the area surrounding the opening in the MPS Mini sensor to prevent the buildup of “stale” air in the enclosure which could affect the response of the sensor.
- For specific integration design questions pertaining to adequate flow of gas to the Mini, contact NevadaNano for guidance.

### 3.2.4. Soldering the MPS Mini Sensor to a PCB

The following guidelines should be followed when soldering the MPS Mini sensor:

1. The plastic enclosure of the MPS Mini *CANNOT* withstand the heat developed in SMT reflow or wave solder operations. In addition, internal components of the sensor can be compromised during the extreme heat of these operations. NevadaNano will not warrant sensors that have been exposed to these processes.
2. The recommended attachment method is manual solder, either by hand soldering or robotic soldering. Use a no-clean flux type wire solder, such as Kester 268 series flux core wire solder (EX: 96-7069-9515) or equivalent.
3. Using the above referenced solder will require a soldering device temperature of between 371-400 °C (700-750 °F). The soldering operation should take no more than 10 seconds per pin.
4. Do not expose the PCB assembly to cleaning operations, using either water or chemical solvents after the MPS sensor has been attached. High-pressure spray from these operations can cause ingress into the MPS sensor opening and damage the sensor.

### 3.2.5. Non-Plated Through-Hole Sizing for MPS Mini

There are two protuberances on the MPS Mini package that are meant to engage non-plated through-holes on the PCB, as shown in Figure 15. If the diameter of the holes is within certain values, the

protrusions will engage the holes with an interference fit. This enables the sensor to be more precisely and securely located relative to the PCB. Otherwise, the holes can be sized for a clearance fit.

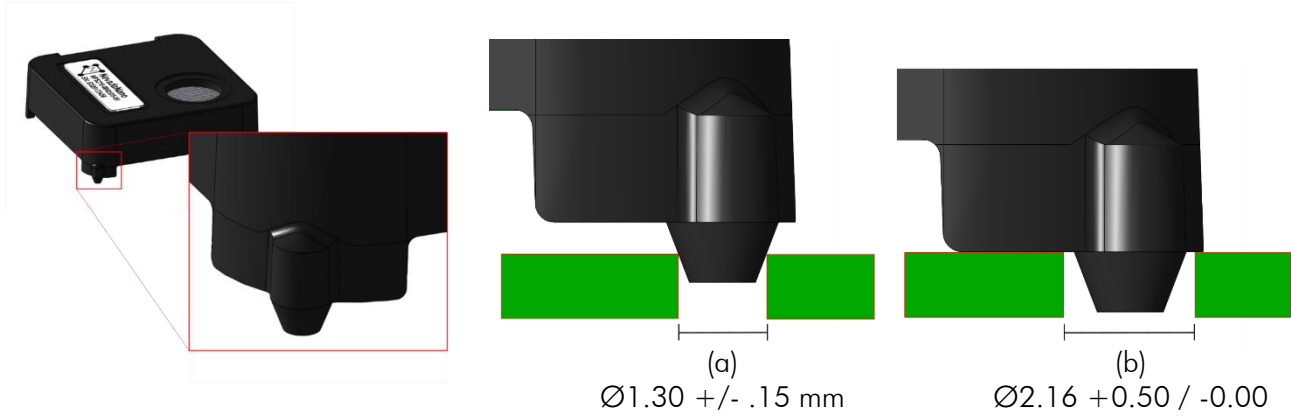

Figure 15: Locating Features. (a) Interference Fit vs (b) Clearance Fit.

Note that when an interference-fit approach is used, the package will not sit perfectly parallel to the plane of the PCB, as shown in Figure 16.

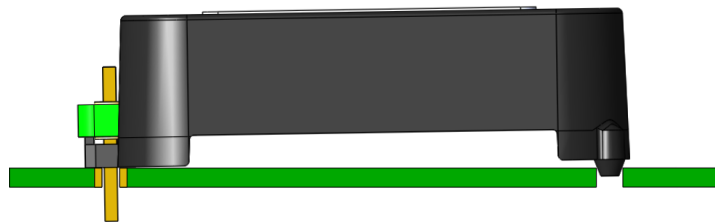

Figure 16: Mini Package with interference-fit of PCB-locating features.

Figure 17 depicts the geometry and tolerance of the conical features.

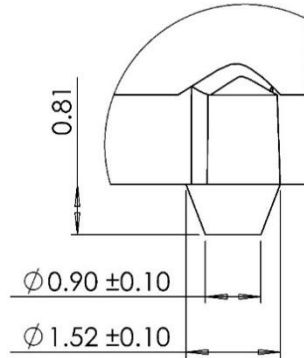

Figure 17: MPS Mini package pin dimensions, in mm.

Hole sizing for an interference fit should be calculated based on the size and location tolerance of the through-holes on the PCB. Nominal hole sizing for an interference fit should be  $\phi 1.30$  mm.

If it is more desirable for the sensor to sit flat on the PCB, through-holes should be sized to at least  $\phi 2.16$  mm to ensure a clearance fit. Figure 18 depicts the dimensions and tolerances for the locating-feature through-holes for both interference and clearance fits.

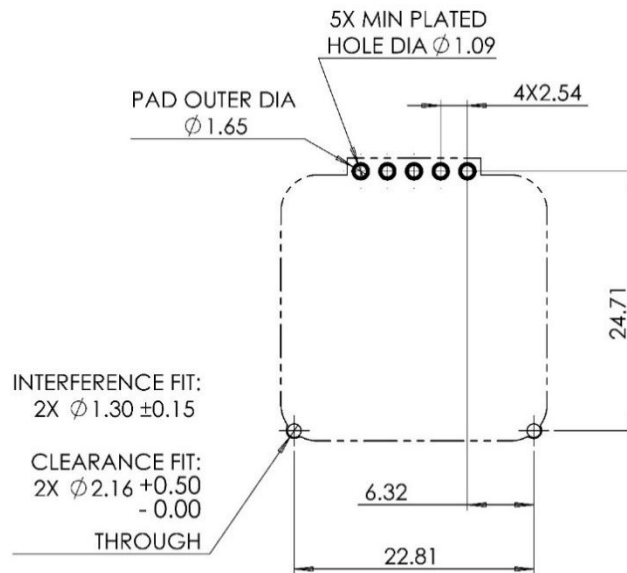

Figure 18: Recommended PCB Layout. Dimensions in mm.

### 3.3. Powering the MPS (Series 4 and Mini)

To power either version of the MPS Flammable Gas Sensor 5.0, the following criteria need to be met:

- **Voltage range must be 3.0-5.0 V  $\pm$  5%**
- **Ripple and noise should not exceed 50 mV**
- **The supply should be capable of providing up to 35 mA without appreciable voltage drop**
  - Note: a typical sensor draws a peak current of 22 mA, but worst-case analysis of electronic component tolerances allows for the statistically improbable possibility of current consumption up to 35 mA. System designers should therefore use 35 mA as a maximum possible current draw, while using an average current of 9.3 mA and peak current of 22 mA for calculation of typical performance, e.g. battery life. The current draw is non-monotonic and will vary based on the internal activity cycle of the sensor.

Note: The Analog Out pin, if unused, must be left unterminated as an "open" or "no-connect" in the system integrator's PCB design.

## 4. Testing the MPS Flammable Gas Sensor 5.0

The MPS measures molecular properties to determine the quantity of flammable gas present in a sample. The system is optimized for "real-world" operation. As such, the effects of humidity, temperature and pressure are automatically compensated out. However, sudden, wholesale changes to the molecular properties of the sample (i.e. artificial changes which can only be generated in a lab test rig) can lead to inaccurate MPS outputs. This of course excludes changes due to the presence of flammable gas. An example of an inadvisable change (shown in Figure 19a, Figure 19d) would be alternating between ambient air (which contains argon, carbon dioxide and other trace gases) and flammable gas + synthetic "zero air" balance (which contains none of the trace constituent gases in ambient air). To properly simulate the real-world application (Figure 19a) in artificial laboratory testing, the same type of "air" must be used for the background and the carrier of the flammable gas for the duration of the test. An example of a proper protocol is shown in Figure 19b. Using a variation of the "incorrect" procedure will invalidate the accuracy of MPS measurements.

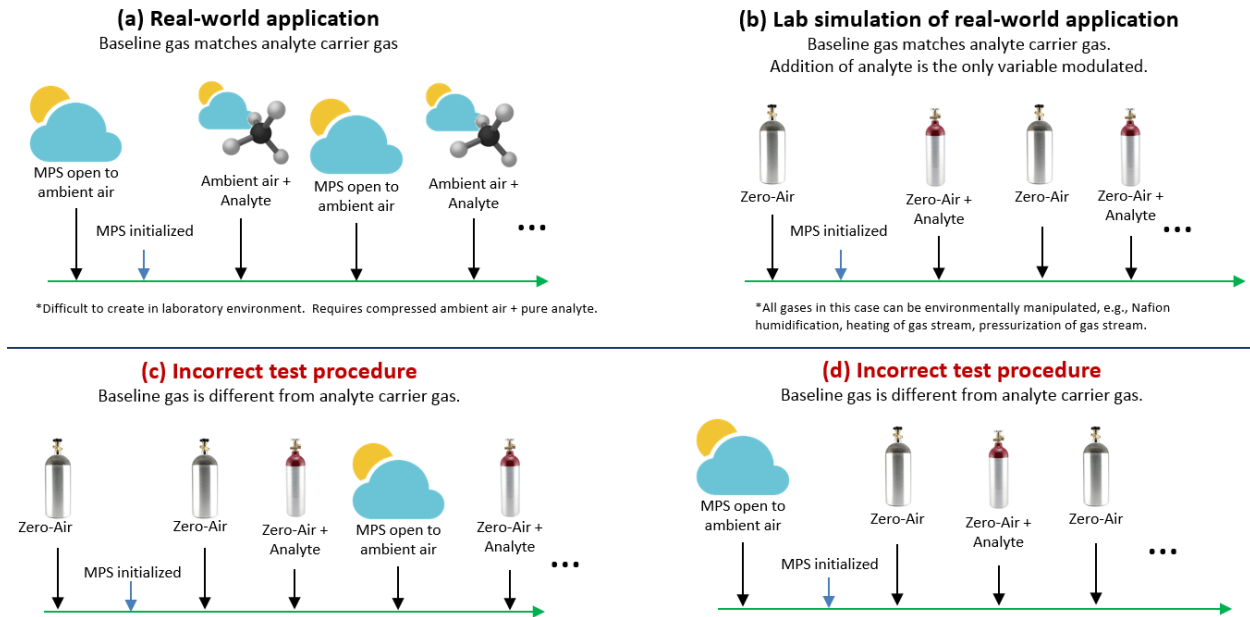

Figure 19: (a) The real-world flammable gas leak scenario. (b) The method for simulating the real-world scenario in a laboratory. Incorrect test procedures are shown in (c) and (d); in these cases, the carrier-only condition does not use the same “air” as the carrier + flammable gas condition, causing inaccurate results.

A “best practice” for performance testing in a laboratory is to use a humidified zero-air background, followed by a switch to a humidified analyte stream with the same zero-air composition as balance gas, then a switch back to humidified zero-air to clear the test chamber. This mimics real-world MPS performance, where flammable gas is introduced into relatively invariant ambient air (Figure 19a).

For best results, make sure the sensor initializes in the same background later used to deliver flammable gases. For example, if testing with flammable gas in a balance of zero air, make sure that the sensor is operating in zero air during start-up and initialization (refer to Figure 6).

Real World Case

Selected, Artificial (“Laboratory”) Use Cases

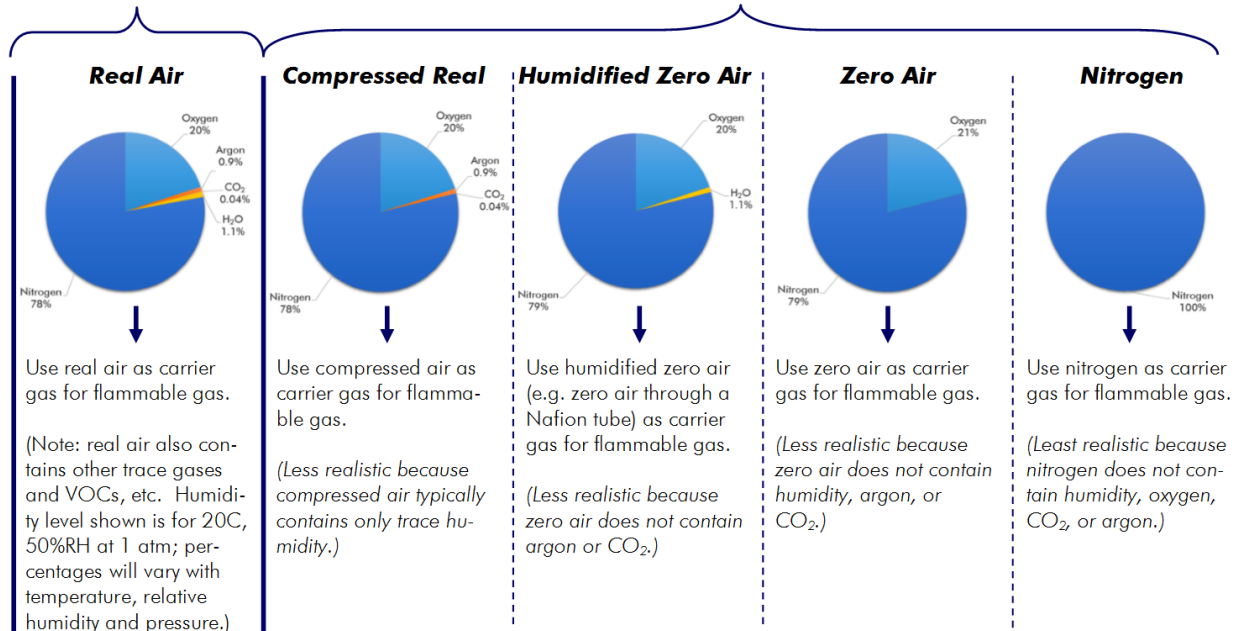

Figure 20: Various “air” options for use as the carrier, or background, gas during flammable gas testing. The best practice is to use one of the options toward the left side of the figure. In addition, do not switch between two different types of “air” during an experiment, as this can produce unwanted (and unrealistic) testing artifacts.

#### 4.1. Typical Test Setups

Various test setups can be used to perform tests with the MPS Flammable Gas Sensor 5.0. One common test setup uses two regulated gas cylinders: zero air (20.9 %volume oxygen in nitrogen), and 50 %LEL methane in a balance of zero air.

##### 4.1.1. Setup #1: Gas Testing in Various Environmental Conditions

Regulated gas cylinders are connected to a gas mixing system (e.g. Environics 4040) to control gas flow rates and concentrations. The gas travels through a heat exchanger and humidity-permeable tubing (e.g. Nafion™ TT-110<sup>1</sup>), allowing the gas to reach the chamber temperature and relative humidity. Gas then flows serially through each of the MPS sensors and out a vent exhaust-tube. The environmental chamber is programmed with the required temperature/humidity profiles for each test. Gas profiles are created in the gas mixing system software to deliver the analyte at the correct time. Flow rate is constant at 300 mL/min for both analyte and zero air throughout the tests.

<sup>1</sup> <https://www.permapure.com/products/nafion-tubing/nafion-dryer-performance-and-selectivity/>

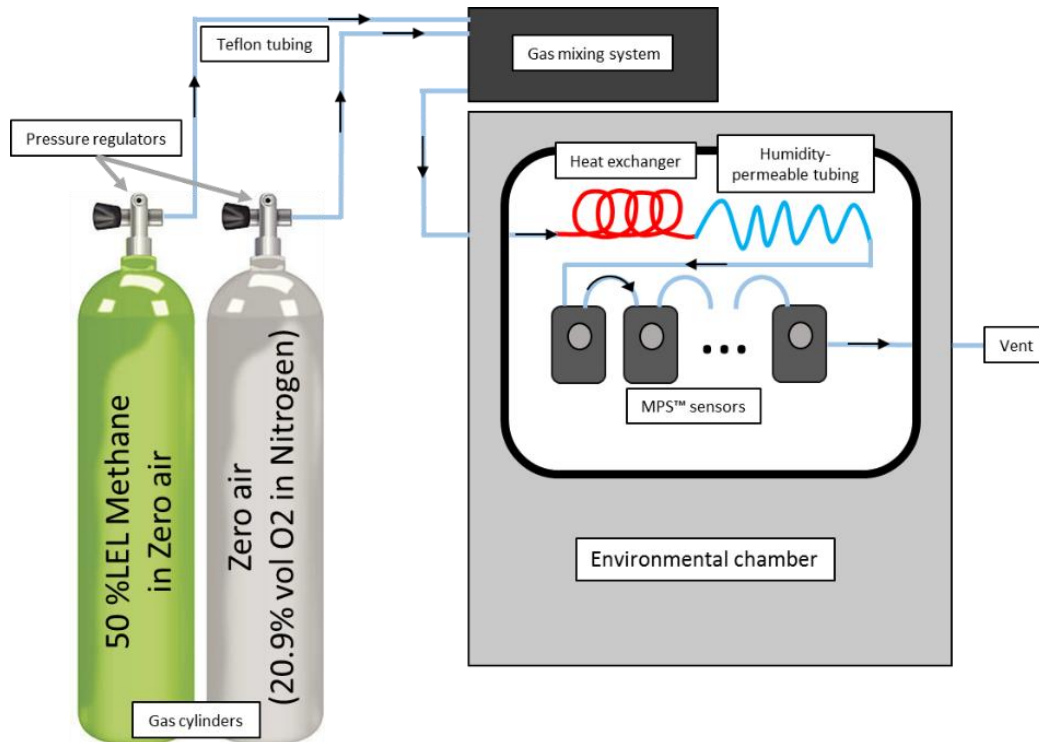

Figure 21: Setup #1: Gas Testing in Various Environmental Conditions.

#### 4.1.2. Setup #2: General Benchtop Testing

Regulated gas cylinders are connected together via a 3-way valve, a rotameter, and humidity-permeable tubing to the sensors. The sensors are encased in a plastic box with a removable lid that seals against the face of the sensor. The lid contains an inlet and an outlet that allows for multiple sensors to be connected in series. The 3-way valve allows gas switching, the rotameter enables flow control, and the Nafion™ tubing humidifies the gas stream. The flow is regulated at 300 mL/min throughout the test to maintain near-constant gas concentration throughout all sensors.

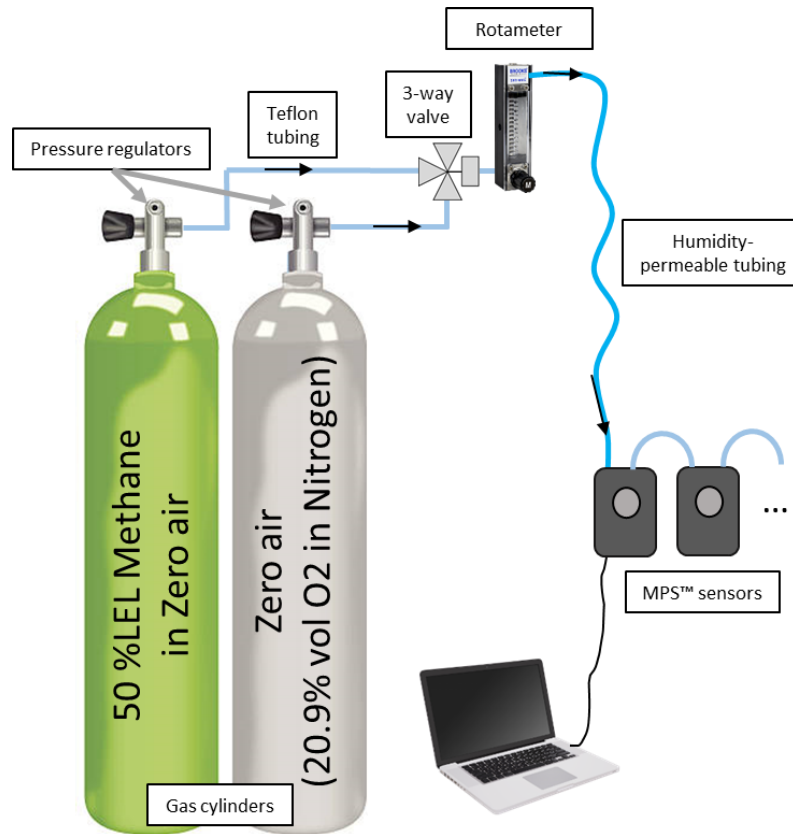

Figure 22: Setup #2: General benchtop testing.

## 4.2. Bump Test Gas Concentrations

The following compressed gas cylinder mixtures can be applied to the MPS while it is already operating in normal, ambient air. Ambient air consists of 78.08% Nitrogen, 20.95% Oxygen, 0.93% Argon, and 0.04% Carbon Dioxide, by volume. This constitutes the air that we typically breathe, only without humidity. The addition of the flammable gas reduces the relative concentrations of the other constituents, with examples shown here for 50 %LEL concentrations of methane (ISO and IEC) and for pentane (ISO); however, this method can also be applied to other flammable gases. Contact NevadaNano for guidance.

Table 13: Compressed gas cylinder mixtures

	Nitrogen	Oxygen	Argon	CO <sub>2</sub>	Flammable Gas
Synthetic (dry) air at 50 %LEL (ISO) methane	76.13%	20.43%	0.91%	0.04%	<b>2.50%</b>
Synthetic (dry) air at 50 %LEL (IEC) methane	76.36%	20.49%	0.91%	0.04%	<b>2.20%</b>
Synthetic (dry) air at 50 %LEL (ISO) pentane	77.49%	20.79%	0.92%	0.04%	<b>0.75%</b>

The following compressed gas cylinder mixtures can be used for single- or multi-gas monitors. These are also applied to the MPS while it is already operating in normal, ambient air.

**Table 14: Single or multi-gas monitor mixture**

	Nitrogen	Oxygen	Argon	CO <sub>2</sub>	Flammable Gas	H <sub>2</sub> S	CO
"Quad Mix" with 50 %LEL (ISO) methane	Balance	18.00%	0%	0%	<b>2.50%</b>	25 PPM	100 PPM
"Quad Mix" with 50 %LEL (IEC) methane	Balance	18.00%	0%	0%	<b>2.20%</b>	25 PPM	100 PPM

The following compressed gas cylinder mixtures can be delivered only if the sensor has been initialized in zero air prior to delivery of the gas. Zero air consists of only 79.1% Nitrogen and 20.9% Oxygen by volume.

**Table 15: Compressed gas mixture after zero air**

	Zero Air	Flammable Gas
50 %LEL (ISO) methane	Balance	<b>2.50%</b>
50 %LEL (IEC) methane	Balance	<b>2.20%</b>

## 5. Environmental Faults and Conditions Affecting Accuracy

The MPS Flammable Gas Sensor 5.0 is specified to operate in the following conditions: –40 to 75 °C, 0 to 100 %RH, and 80 to 120 kPa. The MPS will fail safe and permanently latch to a non-functional state if exposed to extreme excursions (e.g. liquid water inside sensor, or temperatures >85 °C) of specified environmental specifications. The sensor has built-in self-test capabilities to detect and report excursions outside these regimes:

- Fault 0x23, HW\_ENV\_XCD\_RANGE: Environmental (Temp., Press., Humid.) out of range
- Status 0x24, HW\_ENV\_SNSR\_MALFUNCTION: Environmental (Temp., Press., Humid.) extremely out of range. Sensor permanently latches.
- Fault 0x31, CONDENSE\_COND: Condensation condition exists at sensor

The sensor is capable of operating outside of these regimes, as well as during abnormally rapid environmental fluctuations. The impact on sensor performance and output in these conditions is summarized in the following table:

Table 16: Sensor performance in certain conditions

Condition	Fault reported	Impact on sensor performance and output
Sensor environment out of range	0x23 - HW_ENV_XCD_RANGE	The sensor will still detect and report flammable gas, though output accuracy can be diminished while the condition persists.
Condensation condition at sensor	0x31 - CONDENSE_COND	The sensor will still detect and report flammable gas, though output accuracy can be diminished while the condition persists and for one minute afterward.
Breath or humidity surge detected	0x35 - BREATH_OR_HUMIDITY_SURGE	The sensor will still detect and report flammable gas, though output accuracy can be diminished while the condition persists and for 45 seconds afterward.
Rapid humidity changes	None	If the sensor is already reporting flammable gas, no adjustments are made to sensor output. If gas is not being detected, the sensor output may be automatically adjusted to 0 %LEL for a maximum of 10 cycles (20 seconds) in a row during a rapid humidity increase. This adjustment has been programmed such that the largest possible concentration change to go unreported is 15 %LEL (methane). The sensor will still detect and report flammable gas, though accuracy can be diminished for up to 80 seconds.
Rapid temperature change	None	The sensor will still detect and report flammable gas, though output accuracy can be diminished while the condition persists. For an MPS sensor exposed on all sides to ambient air, it is possible for this condition to occur when moving from conditioned, indoor air to cold or hot outdoor conditions, or vice versa. For MPS sensors integrated in portable or fixed detector units, the added thermal mass and insulation provided by the unit serves to slow the thermal transients acting on the MPS, making this condition less likely.

Sensor accuracy can also be diminished in certain cases of extremely slow gas accumulation occurring over time scales of many hours or days. These cases are still detected by the MPS, and reported via the fault message “SENSOR\_SLOW\_GAS\_ACCUMULATION\_DETECTED.” However, because TrueLEL accuracy is not available in this fault case, it is recommended that the detector output a high gas alarm (>50%LEL).

## 6. Hazardous Locations and System Integration

Integrating the MPS into intrinsically safe systems requires additional design consideration. Refer to the MPS Hazardous Locations User Guide (<https://nevadanano.com/downloads/>) for information regarding certifications, protection concepts, entity parameters, etc.

## 7. Sensor Data for Temperature, Humidity, and Pressure

The MPS Flammable Gas Sensor 5.0 is equipped with an integrated sensor that measures temperature, humidity, and pressure. These data are available to end users (Section 2.1.6) and are generally representative of ambient environmental conditions; note, however, the MPS environmental sensor measures the conditions *within* the sensing chamber, which may not perfectly match ambient environmental conditions due to the slight self-heating of the sensor chamber by the MPS’ internal electronics. Typically, environmental readings provided by the MPS are slightly warmer than ambient

(approximately 4 °C) and have lower *relative* humidity than ambient (approximately 10-20 %RH), while the *absolute* humidity (which can be calculated, if desired, using the MPS' temperature and relative humidity outputs) tends to track well with the ambient absolute humidity. MPS environmental readings are dependent on the temperature and heating profile of the system into which the sensor is integrated and the MPS' proximity to components that generate additional heat.

## 8. Warranty information

MPS Flammable Gas Sensors carry a 2-year warranty against defects in materials and workmanship, as specified in the Standard Limited Warranty in Section 8.1. The warranty is voided if the sensors are used under conditions other than those specified in the sensor datasheet or this user manual. Please pay particular attention to these things:

- Do not use or otherwise expose the sensor to the following environmental conditions:
  - Temperatures above 90°C or less than –60°C
  - Ambient pressures above 130 kPa or less than 30 kPa
- Do not allow water or other liquids to accumulate inside the sensor
- Do not solder to the S4 sensor pins
- Observe the correct supply polarity and voltage ranges

### 8.1. MPS Flammable Gas Sensor 5.0 Standard Limited Warranty

Nevada Nanotech Systems, Inc. warrants its MPS Flammable Gas Sensor 5.0, (referred to hereafter as the Product) manufactured and sold by Nevada Nanotech Systems, Inc. to be free from defects in materials and workmanship for a period of two years from the date of original purchase. This warranty is expressly limited to the original owner who purchases the equipment directly from Nevada Nanotech Systems, Inc. or from an authorized Nevada Nanotech Systems Distributor and is non-transferrable.

To maintain this limited warranty, the product must be operated, used, and maintained in accordance with the conditions specified in the MPS™ Flammable Gas Sensor 5.0 Datasheet, the MPS™ Flammable Gas Sensor 5.0 User Manual, and the MPS™ Hazardous Locations User Guide. Abuse, mechanical damage, alterations, or other operations not done in accordance with these documents voids the Nevada Nanotech Systems Standard Limited Warranty.

With respect to firmware, the obligation of Nevada Nanotech Systems under this limited warranty is limited to a firmware upgrade, performed by Nevada Nanotech Systems, when such upgrade is deemed necessary, solely by Nevada Nanotech Systems, to address a critical safety or functional issue. This warranty is limited to the above and expressly excludes firmware upgrades that include enhanced or modified functionality of features.

Nevada Nanotech Systems does not warrant that the electronic or software operation of the Product will be uninterrupted or error-free, or that all such errors may be corrected. In addition to all other limitations, this limited warranty is limited by and does not apply to the following: (1) products or parts

that have been altered or modified (e.g., to alter functionality or capability) by anyone other than Nevada Nanotech Systems; (2) damage caused by use with another product; (3) damage caused by accident, abuse, misuse, liquid contact, fire, or other external cause; (4) damage caused by operating the Product outside Nevada Nanotech System product guidelines; (5) Products whose electronic module housings have been opened or otherwise tampered with; and (6) defects caused by normal wear and tear or otherwise due to the normal aging of the Product, unless damage has occurred due to a defect in materials or workmanship.

This limited warranty is expressly in lieu of any and all representations, express or implied, including but not limited to the warranty of fitness for a particular purpose. Nevada Nanotech Systems will not be liable for loss or damage of any kind connected to the use of its products or failure of its products to function or operate properly.

REPAIR OR REPLACEMENT AS PROVIDED UNDER THIS LIMITED WARRANTY IS THE EXCLUSIVE REMEDY OF THE PURCHASER. EXCEPT FOR THE WARRANTIES CONTAINED IN THIS LIMITED WARRANTY, NEVADA NANOTECH SYSTEMS MAKES NO OTHER WARRANTY OF ANY KIND, EXPRESS OR IMPLIED, IN FACT OR BY LAW, WHETHER OF MERCHANTABILITY, FITNESS FOR ANY PARTICULAR PURPOSE OR OTHERWISE. NO ADVICE OR INFORMATION, WHETHER ORAL OR WRITTEN, OBTAINED FROM NEVADA NANOTECH SYSTEMS OR ELSEWHERE, WILL CREATE ANY WARRANTY NOT EXPRESSLY STATED IN THESE TERMS AND CONDITIONS. YOUR SOLE AND EXCLUSIVE REMEDY UNDER THIS LIMITED WARRANTY SHALL BE PRODUCT REPAIR OR REPLACEMENT AS PROVIDED HEREIN. NEVADA NANOTECH SYSTEMS SHALL NOT BE LIABLE FOR INDIRECT, INCIDENTAL, PUNITIVE, OR CONSEQUENTIAL DAMAGES OF ANY NATURE WHATSOEVER. NEVADA NANOTECH SYSTEMS IS NOT RESPONSIBLE FOR ANY LOSS OF PROFITS OR REVENUES. NEVADA NANOTECH SYSTEMS IS NOT RESPONSIBLE FOR ANY DAMAGE TO PROPERTY OR PERSONS CAUSED BY YOUR USE OF THE PRODUCT, INCLUDING YOUR FAILURE TO UNDERSTAND THE FUNCTIONALITIES OF THE PRODUCT OR FAILURE TO DETERMINE THE SUITABILITY OF THE PRODUCT FOR YOUR INTENDED USE. IN NO EVENT WILL OUR LIABILITY EXCEED THE AMOUNT PAID BY YOU FOR THE PRODUCT.

The foregoing limitations will apply even if any warranty or remedy provided under this Agreement fails of its essential purpose. Some jurisdictions do not allow exclusion or limitation of incidental or consequential damages or how long an implied warranty lasts, so the above limitations may not apply to you. This limited warranty gives the Purchaser specific legal rights, and the Purchaser may also have other additional rights, which vary from State to State or by countries.

In the event of any dispute regarding the Product, prior to bringing any civil suit, the Purchaser and Nevada Nanotech Systems agree to resolve any Claims by ARBITRATION that must be brought through a mutually acceptable arbitrator in Reno, Nevada. Such arbitration will be conducted under the Commercial Arbitration Rules (Amended and Effective October 1, 2013) of the American Arbitration Association (available at <http://www.adr.org/commercial>). For the purposes of this section, references to "Purchaser" include the original OEM manufacturer, its officers, directors, employees, customers, beneficiaries, and assigns, and references to "Claim" shall include any dispute, claim or controversy arising from or relating to: (1) the Product, whether based in contract; tort; fraud; misrepresentation; state or federal statute, regulation, ordinance; or any other legal or equitable theory, and (2) this limited warranty. There shall be no right or authority for any Claims to be

arbitrated on a class action basis. This Dispute Resolution agreement is part of a transaction involving interstate commerce and is governed by the Federal Arbitration Act, which governs its enforcement and interpretation.

No other person or company is authorized to change this limited warranty, and the Purchasers are solely responsible for any other additional warranties regarding any other products that the Products are incorporated into.

To obtain warranty service for the Product, the Purchaser must contact Nevada Nanotech Systems by calling +1 775 972 8943, or emailing [returns@nevadanano.com](mailto:returns@nevadanano.com). Nevada Nanotech Systems will provide a Return Merchandise Authorization (RMA) form for the Purchaser to complete. The Purchaser is responsible for any necessary shipping charges for returned or replaced products and all returns must be clearly marked with the RMA number issued. Nevada Nanotech Systems will decide, at its discretion, to repair or replace any of its Products found to be defective. Any replacement under this limited warranty will only be made with the same or similar product of the same or similar value and will not include cash, credits, or other types of products. All repaired or replacement products will be covered for two years from the date of the original purchase. If Nevada Nanotech Systems determines that the problem with the Product is not covered under this limited warranty, Nevada Nanotech Systems will notify the Purchaser and inform the Purchaser of service or replacement alternatives that are available on a fee basis.

Nevada Nanotech Systems, Inc.  
1395 Greg St, Suite 102  
Sparks, NV 89431  
Phone: +1 775 972 8943



Nevada Nanotech Systems Inc.  
1395 Greg Street, Suite 102  
Sparks, Nevada 89431  
United States  
Tel: +1 775 972 8943  
Fax: +1 775 972 8078  
[info@nevedanano.com](mailto:info@nevedanano.com)  
[www.nevedanano.com](http://www.nevedanano.com)